

ABOUT US	
Chairman's Message	05
Company Overview	07
Vision Mission	08
Our Factory & Capabilities	10

CERTIFICATION	
Quality Assurance	11
Certificates	12

PRODUCTS	15
-----------------	----

OUR KEY PROJECTS	195
-------------------------	-----



CHAIRMAN'S MESSAGE

The Group is committed to Corporate Social Responsibility and actively supports a variety of projects across the UAE and the surrounding region. We take pride in sponsoring both international and local companies that are driven by talent and resilience - the people who form the foundation of our growth.

I feel privileged to lead such a diverse organization and am proud of our people's accomplishments. I am confident that our Group will continue to thrive, fueled by the energy and innovation of our team, delivering growth and superior returns in the years ahead.

I would like to welcome you to the product offerings at Emirates Lighting Factory. I invite you to explore our wide range of products, designed for various applications and backed by authentic quality and warranty.

Get to know our people and our products, you will discover what makes us the successful entity we are – Rich in history and diversity.

Engr. Saayah Mohamed Musa Al Qubaisi
Bin Moosa Group L.L.C.



EMIRATES LIGHTING

The torchbearer for innovation in lighting

Founded in 1995, Emirates Lighting Factory LLC, part of the highly reputed Bin Moosa Group, Abu Dhabi, is one of the UAE's leading manufacturers and suppliers of premium lighting solutions.

With over 30 years of market presence, Emirates Lighting Factory, known for its quality and reliability, enjoys a large base of repeat and satisfied customers. We specialize in designing and producing energy-efficient, sustainable, and high-quality lighting systems for residential, commercial, industrial, retail, hospitality, and outdoor applications.

Innovation is our driving force, and we offer tailor-made lighting solutions to our customers, making us a preferred partner for all their lighting requirements. From architectural and decorative luminaires to intelligent LED lighting solutions, Emirates Lighting offers a comprehensive range of competitively priced lighting products that balance efficiency, durability, and aesthetics.

VISION

To illuminate every space with innovative, sustainable, aesthetically designed lighting solutions that inspire and elevate experiences, while providing exceptional quality, energy efficiency, and cutting-edge technology for every customer.

MISSION

To provide our customers with high-quality, energy efficient lighting solutions that enhance spaces, inspire creativity, and deliver long lasting value. We are committed to offering innovative products, exceptional customer service, and sustainable design to illuminate every project with precision and style.



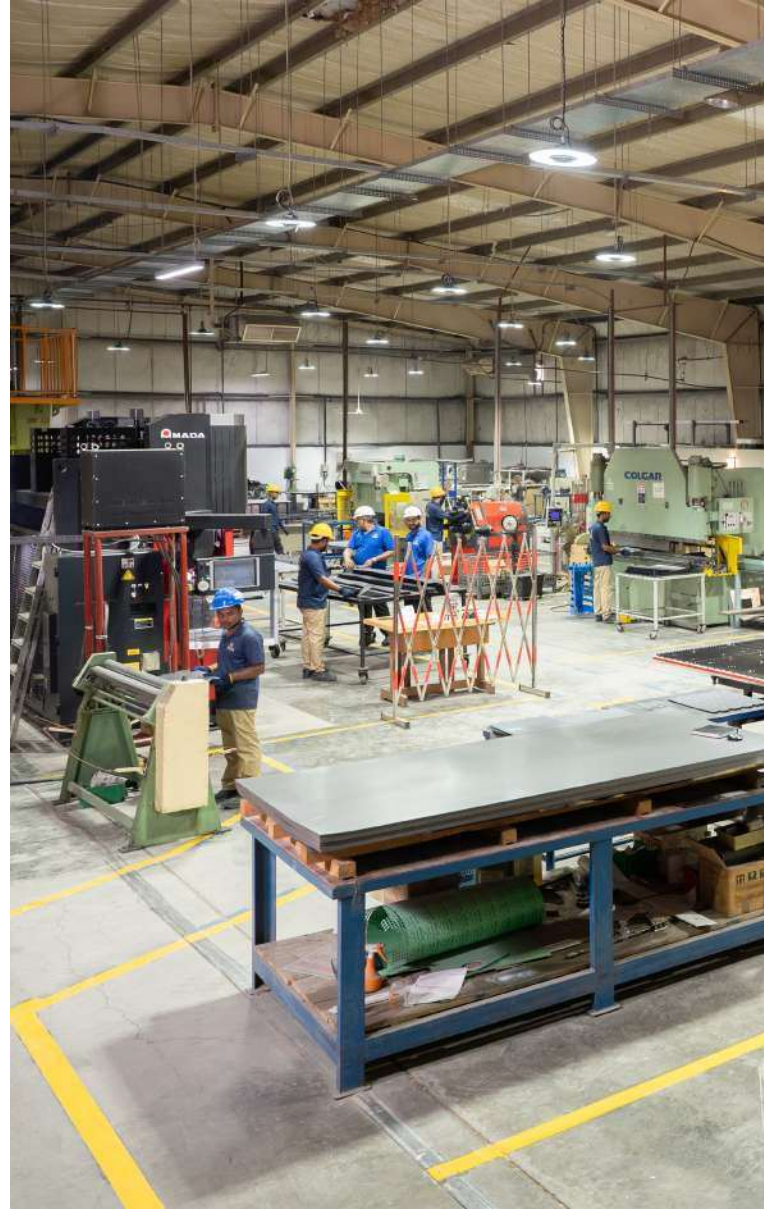

FACTORY & CAPABILITIES

Our manufacturing facility is equipped with advanced machinery and quality assurance systems to ensure consistent and reliable performance. with focus on:

- Futuristic Manufacturing
- Focus on Automation & Innovation
- Reliable & Repeatable Aluminum Die-Casting
- Engineered for Precision
- Powder Coating & Painting Systems
- Testing & Analysis Laboratory



QUALITY ASSURANCE

At Emirates Lighting Factory, quality is monitored at every stage, starting from inward inspection to finished product validation. We use certified and calibrated equipment, including goniophotometers, integrating spheres, power analyzers, and HI Pot testers, to ensure performance, safety, and durability in accordance with IEC standards.

Our testing covers:

- Light distribution and photometric data – IES files
- Electrical Safety Test
- Power Quality Test
- Aging tests using automatic aging racks
- Powder paint thickness and gloss testing

AWARDS & CERTIFICATIONS

Received the prestigious Sheikh Khalifa Industry Award (2005) in recognition of exceptional quality excellence



Certifications reflect our commitment to sustainability, safety, and quality excellence in every product we deliver.

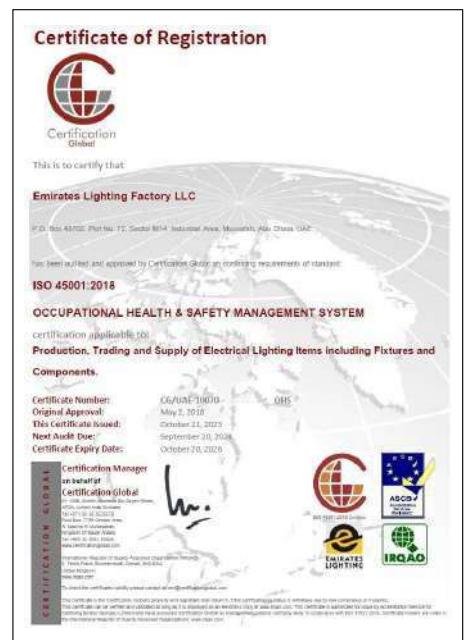
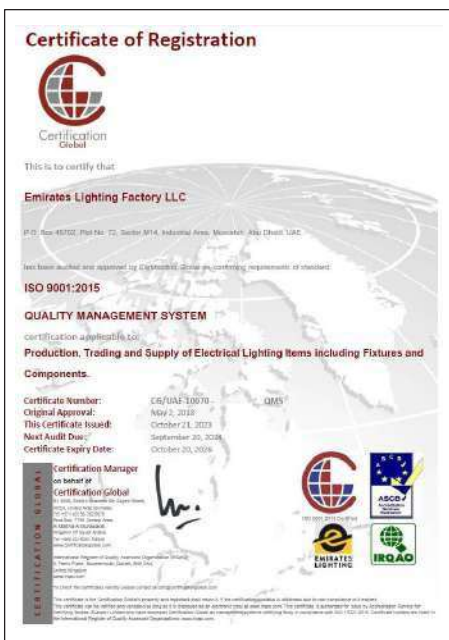





LED BACK LIT PANEL SERIES

Elevate your lighting experience with our cutting-Back Lit Panel Light Series, engineered to combine sleek design, superior efficiency, and unmatched reliability. Designed for both commercial and residential applications, our panel lights offer uniform illumination, reduced glare, and optimal energy savings—making them the perfect solution for modern spaces.



ELPN-5020



ELPN-5040

ELPN-5020



APPLICATIONS:

Schools, Commercial Spaces,
Rest Rooms, Shower Area,
& Industrial Environments

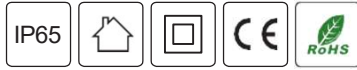

Features

- Higher Lumen efficiency 120 lm/W
- Rated Life Time: 50,000 Hrs

Optional Features

- Dimming (DALI/0-10V/1-10V/Phase Dimming)
- Emergency Back up
- Micro prismatic diffuser for glare Control
- Panel Accessories Available

PRODUCT PARAMETERS

PHYSICAL	
Housing	SPCC Cold Rolled Steel
Diffuser	Polystyrene
Finish	RAL 9016
Mounting	Surface Mounted/Suspended /Recessed
OPTICAL	
Beam Angle	110°/90°
UGR	<22;<19
ELECTRICAL	
CRI	≥80
CCT	3000K/4000K/6000K
Voltage / Frequency	220-240 VAC / 50-60Hz
Operating Temperature	-25°C to +40°C
Driver	Remote

PRODUCT DETAILS

Product Code	Wattage	Lumen	Product Size
ELPN 5020-A	26/30/36/40W	3120/3600/4320/4800 lm	L595xW595xH30 mm
ELPN 5020-B	26/30/36/40W	3120/3600/4320/4800 lm	L295xW1195xH30 mm
ELPN 5020-C	50W	6000 lm	L595xW1195xH30 mm

PRODUCT DRAWING

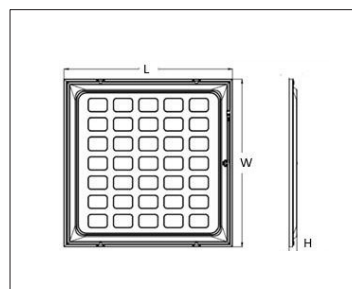

LIGHT DISTRIBUTION

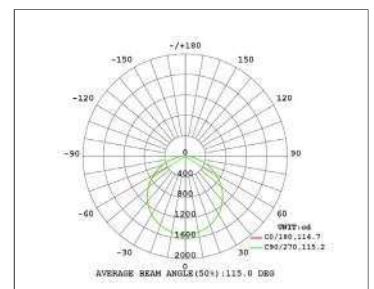

ELPN-5040



APPLICATIONS:

Schools, Commercial Spaces,
Rest Rooms, Shower Area,
& Industrial Environments

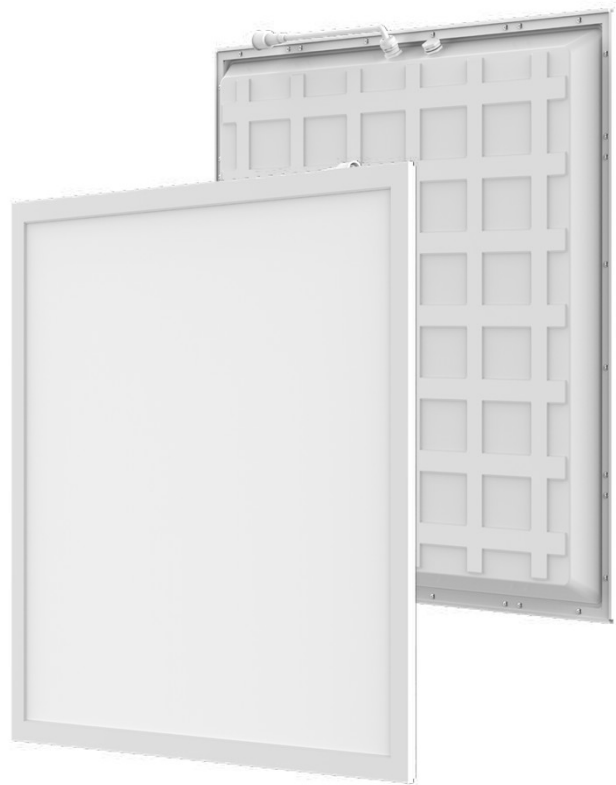
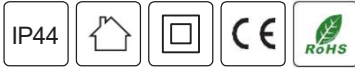

Features

- Higher Lumen efficiency 110 lm/W
- Rated Life Time: 50,000 Hrs

Optional Features

- Dimming (DALI/0-10V/1-10V/Phase Dimming)
- Panel Accessories Available
- Emergency Back up
- IP54 Available upon Request
- Micro prismatic diffuser for glare Control

PRODUCT PARAMETERS

PHYSICAL	
Housing	SPCC Cold Rolled Steel
Diffuser	Polystyrene
Finish	RAL 9016
Mounting	Surface Mounted/Suspended /Recessed
OPTICAL	
Beam Angle	110°/90°
UGR	<22;<19
ELECTRICAL	
CRI	≥80
CCT	3000K/4000K/6000K
Voltage / Frequency	220-240 VAC / 50-60Hz
Operating Temperature	-25°C to +40°C
Driver	Remote

PRODUCT DETAILS

Product Code	Wattage	Lumen	Product Size
ELPN 5040	26W	2860 lm	L595x W595 XH37 mm
	30W	3300 lm	
	36W	3960 lm	
	40W	4400 lm	
	45W	4950 lm	

PRODUCT DRAWING

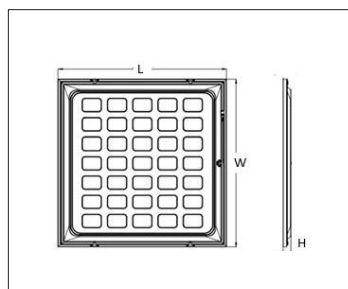

LIGHT DISTRIBUTION

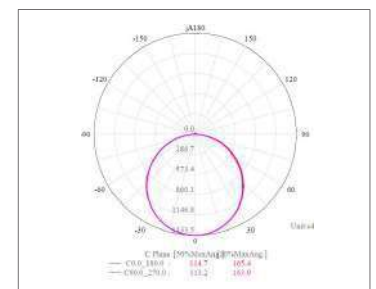



LED TROFFER PANEL SERIES

Illuminate your space with our advanced LED Troffer Light Series—a perfect blend of energy efficiency, durability, and sleek design. With a range of customizable options, our LED Troffer Lights are perfect for grid ceilings in offices, schools, hospitals, retail spaces, and more. Enjoy reduced energy consumption, extended lifespan, and improved light quality, all while lowering your overall operational costs.



ERI-PR



ELTR-5410



ELTR-5420

ERI-PR



APPLICATIONS:

Schools, Universities, Hospital,
Healthcare Facilities & Retail Stores

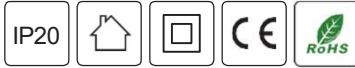

Features

- Higher Lumen efficiency 130 lm/W
- Rated Life Time: 50,000 Hrs

Optional Features

- Dimming (DALI/0-10V/1-10V/Phase Dimming)
- Emergency Back up

PRODUCT PARAMETERS

PHYSICAL	
Housing	SPCC Cold Rolled Steel
Diffuser	Polycarbonate
Finish	RAL 9016
Mounting	Recessed
OPTICAL	
Beam Angle	120°
UGR	-
ELECTRICAL	
CRI	>80
CCT	3000K/4000K/6000K
Voltage / Frequency	220-240 VAC / 50-60Hz
Operating Temperature	-25°C to +40°C
Driver	Remote

PRODUCT DETAILS

Product Code	Wattage	Lumen	Product Size
ERI PR-A	26W/30W/36W/40W	3380/3900/4680/5200 lm	L595xW595xH50mm
ERI PR -B	26W/30W/36W/40W	3380/3900/4680/5200 lm	L295xW1195xH50mm
ERI PR-C	30/40/50W	3900/5200/6500 lm	L595xW1195xH50mm

PRODUCT DRAWING

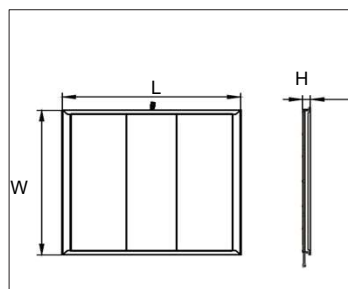

LIGHT DISTRIBUTION

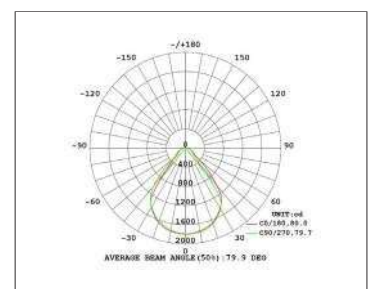

ELTR-5410



APPLICATIONS:

Schools, Universities, Hospital,
Healthcare Facilities & Retail Stores

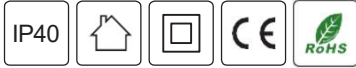

Features

- Higher Lumen efficiency 120 lm/W
- Rated Life Time: 50,000 Hrs

Optional Features

- Dimming (DALI/0-10V/1-10V/Phase Dimming)
- Emergency Back up

PRODUCT PARAMETERS

PHYSICAL	
Housing	SPCC Cold Rolled Steel
Diffuser	Polycarbonate
Finish	RAL 9016
Mounting	Recessed/Surface Mount/Suspended
OPTICAL	
Beam Angle	100°
UGR	<19
ELECTRICAL	
CRI	>80
CCT	3000K/4000K/6000K
Voltage / Frequency	220-240 VAC / 50-60Hz
Operating Temperature	-25°C to +40°C
Driver	Remote

PRODUCT DETAILS

Product Code	Wattage	Lumen	Product Size
ELTR 5410-A	36W	4320 lm	L595xW595xH36mm
ELTR 5410-B	36W	4320 lm	L1195xW295xH36mm

PRODUCT DRAWING

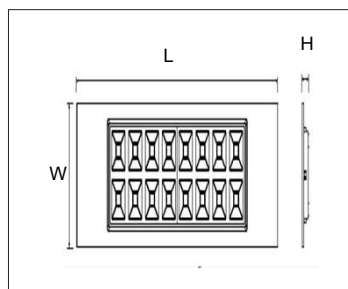

LIGHT DISTRIBUTION

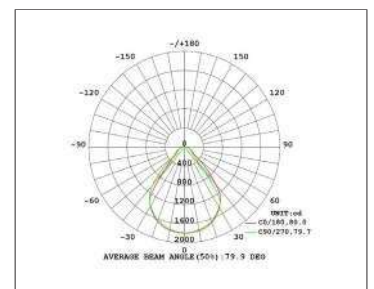

ELTR-5420



APPLICATIONS:

Schools, Universities, Hospital,
Healthcare Facilities & Retail Stores

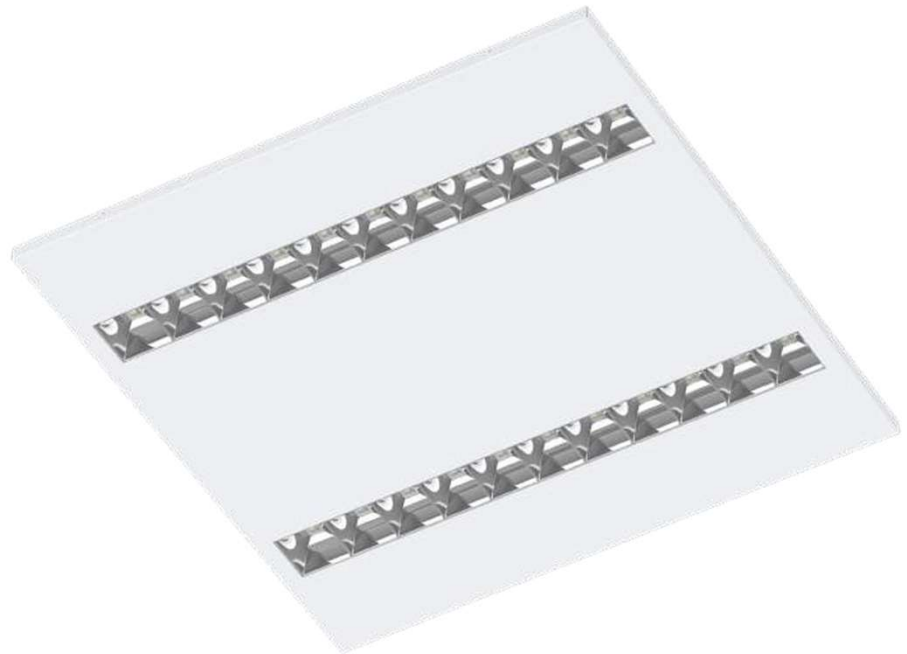

Features

- Multiple Reflector Available
- Higher Lumen efficiency 110 lm/W
- Rated Life Time: 50,000 Hrs

Optional Features

- Dimming(DALI/0-10V/1-10V/Phase Dimming)
- Emergency Back up

PRODUCT PARAMETERS

PHYSICAL	
Housing	SPCC Cold Rolled Steel
Diffuser	Polycarbonate
Finish	RAL 9016
Mounting	Recessed/Surface Mount/Suspended
OPTICAL	
Beam Angle	75°(Matt Silver)/65°(Black & Bright Silver)/80°(White)
UGR	<19 / White (No Antiglare)
ELECTRICAL	
CRI	≥80
CCT	3000K/4000K/6000K
Voltage / Frequency	220-240 VAC / 50-60Hz
Operating Temperature	-25°C to +40°C
Driver	Remote

PRODUCT DETAILS

Product Code	Wattage	Lumen	Product Size
ELTR 5420-A	30W	3300 lm	L595xW595xH31.5mm
ELTR 5420-B	30W	3300 lm	L295xW1195xH31.5mm
ELTR 5420-C	55W	6050 lm	L595xW1195xH31.5mm

PRODUCT DRAWING

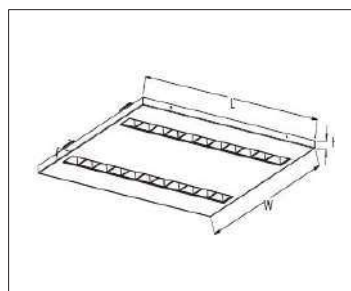

LIGHT DISTRIBUTION

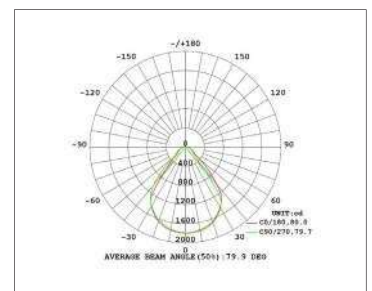





LED CLEAN ROOM PANEL SERIES

Engineered to meet the highest standards of cleanliness and performance, our LED Clean Room Panel Series provides ultra-clean, uniform lighting ideal for sterile environments like laboratories, healthcare facilities, pharmaceutical plants, and electronics manufacturing areas. These panel lights deliver exceptional performance, energy efficiency, and reliability while adhering to the stringent requirements of cleanroom environments.



ERCO



ERCO-5200

APPLICATIONS:

Dust-free Plant, Laboratory, Hospital, Pharmaceuticals

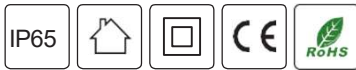

Features

- Rated Life Time: 50,000Hrs
- Optional Features
 - Dimming(DALI/0-10V/1-10V/Phase Dimming)
 - Emergency Back up

PRODUCT PARAMETERS

PHYSICAL	
Housing	SPCC Cold Rolled Steel
Diffuser	Polycarbonate
Finish	RAL 9016
Mounting	Recessed
OPTICAL	
Beam Angle	120°
UGR	--
ELECTRICAL	
CRI	>80
CCT	3000K/4000K/6000K
Voltage / Frequency	220-240 VAC / 50-60Hz
Operating Temperature	-25°C to +40°C
Driver	In Built

PRODUCT DETAILS

Product Code	Wattage	Dimension	Mounting Hole
ERCO	30W	L596xW596xH100 mm	586x586 mm
	35W	L596xW596xH100 mm	586x586 mm
	40W	L596xW596xH100 mm	586x586 mm
	45W	L296xW1190xH100 mm	296x1200 mm

PRODUCT DRAWING

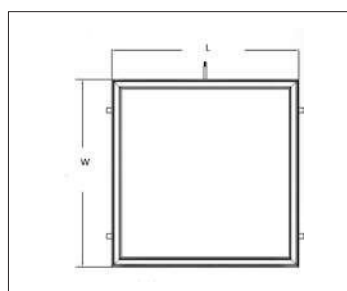

LIGHT DISTRIBUTION

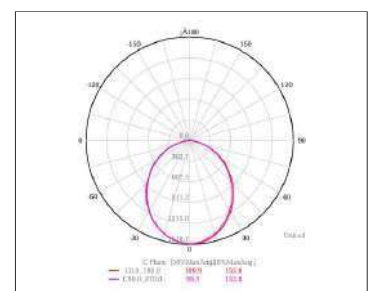

ERCO-5200



APPLICATIONS:

Dust-free Plant, Laboratory, Hospital,
Pharmaceuticals

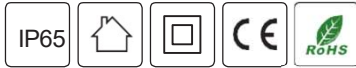

Features

- Higher Lumen efficiency 120 lm/W
- Rated Life Time: 50,000Hrs
- Screwless Design

Optional Features

- Dimming(DALI/0-10V/1-10V/Phase Dimming)
- Emergency Back up
- 140lm/W also Available

PRODUCT PARAMETERS

PHYSICAL	
Housing	Aluminium
Diffuser	Polycarbonate /Tempered Glass /Anti-Virus PC
Finish	RAL 9016
Mounting	Recessed
OPTICAL	
Beam Angle	110°,90°
UGR	<22, <19
ELECTRICAL	
CRI	>80
CCT	3000K/4000K/6000K
Voltage / Frequency	220-240 VAC / 50-60Hz
Operating Temperature	-25°C to +40°C
Driver	In Built

PRODUCT DETAILS

Product Code	Wattage	Lumen	Product Size
ERCO 5200-A	26/30/36/40W	3120/3600/4320/4800 lm	L595xW595xH100mm
ERCO 5200-B	26/30/36/40W	3120/3600/4320/4800 lm	L295xW1195xH100mm
ERCO 5200-C	40/50/72W	4800/6000/8640 lm	L595xW1195xH100mm

PRODUCT DRAWING

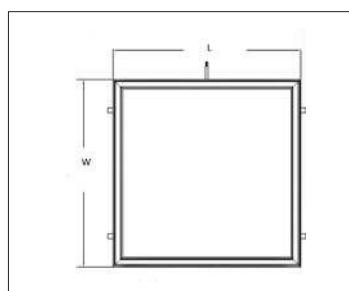

LIGHT DISTRIBUTION

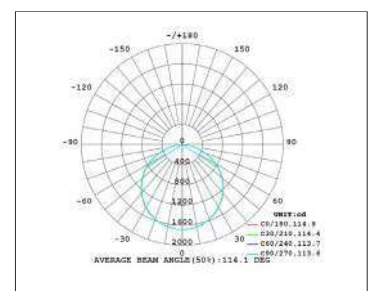



RECESSED DOWNLIGHT SERIES

Our LED Recessed Downlight Series combines energy saving performance with sleek, modern aesthetics to deliver a high-quality lighting solution for residential, commercial, and hospitality spaces. Designed to fit effortlessly into ceilings, these round lights offer glare-free, uniform light that enhances comfort and visual appeal in any environment.



ERPDL



ELRD-1001



ELRD-1002



ELRD-1003

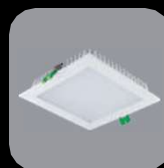

ELRD-1004



ELRD-1005

APPLICATIONS:
 Offices, Meeting Rooms,
 Schools, Retail Stores,
 Libraries & Reading Areas

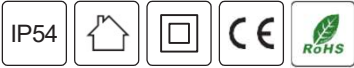

PRODUCT DETAILS

Product Code	Wattage	Lumen	Cutout	Product Size
ERPDL	8W	800 lm	75mm	Ø85xH70 mm
	12W	1200 lm	85mm	Ø100xH80 mm
	15W	1500 lm	140mm	Ø160xH112 mm
	18W	1800 lm	140mm	Ø160xH112 mm
	20W	2000 lm	140mm	Ø160xH112 mm
	25W	2500 lm	175mm	Ø193xH112 mm
	30W	3000 lm	175mm	Ø193xH112 mm
	35W	3500 lm	175mm	Ø193xH112 mm
	40W	4000 lm	220mm	Ø230xH180 mm
45W	4500 lm	220mm	Ø230xH180 mm	

Features

- Rated Life Time: 50,000Hrs

Optional Features

- Dimming(DALI/0-10V/1-10V/Phase Dimming)
- Emergency Back up

PRODUCT PARAMETERS

PHYSICAL	
Housing	Die-Cast Aluminium
Diffuser	Opal-Polycarbonate Clear / Centre Frosted-Glass
Finish	RAL 9016 / RAL 9005
Mounting	Recessed
OPTICAL	
Beam Angle	24°/60°
UGR	-
ELECTRICAL	
CRI	≥80(≥90 upon Request)
CCT	3000K/4000K/6000K
Voltage / Frequency	220-240 VAC / 50-60Hz
Operating Temperature	-25°C to +45°C
Driver	Driver Remote

PRODUCT DRAWING

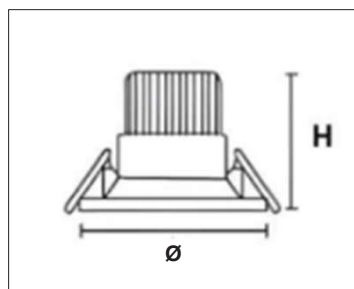

LIGHT DISTRIBUTION

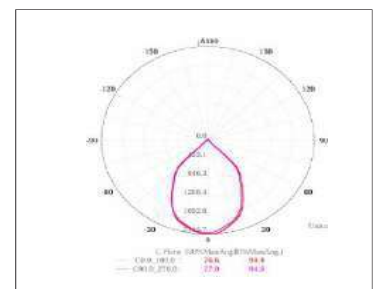

ELRD-1001

APPLICATIONS:

Offices, Meeting Rooms,
Schools, Retail Stores,
Libraries & Reading Areas



Features

- Higher Lumen efficiency 90- 110 lm/W
- Rated Life Time: 50,000Hrs

Optional Features

- Dimming(DALI/0-10V/1-10V/Phase Dimming)
- Emergency Back up

PRODUCT PARAMETERS

PHYSICAL	
Housing	Die-Cast Aluminium
Diffuser	Clear Glass
Finish	RAL 9016 / RAL 9005
Mounting	Recessed
OPTICAL	
Beam Angle	40°/60°
UGR	--
ELECTRICAL	
CRI	≥80 (≥90 upon Request)
CCT	3000K/4000K/6000K
Voltage / Frequency	220-240 VAC / 50-60Hz
Operating Temperature	-25°C to +45°C
Driver	Remote

PRODUCT DETAILS

Product Code	Wattage	Lumen	Cutout	Product Size
ELRD 1001-A	9W	800 lm	90-100 mm	Ø110xH42.2 mm
ELRD 1001-B	12W	1100 lm	90-100 mm	Ø110xH42.2 mm
ELRD 1001-C	15W	1500 lm	125-130 mm	Ø140xH53.3 mm
ELRD 1001-D	20W	2200 lm	145-150 mm	Ø162xH64 mm
ELRD 1001-E	28W	3300 lm	145-150 mm	Ø162xH64 mm

PRODUCT DRAWING

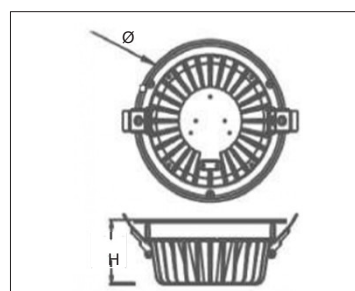

LIGHT DISTRIBUTION

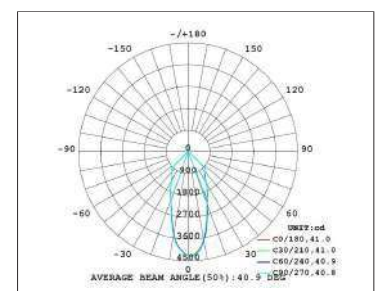

ELRD-1002

APPLICATIONS:

Offices, Meeting Rooms,
Schools, Retail Stores,
Libraries & Reading Areas

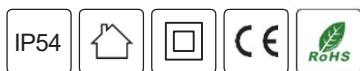

Features

- Rated Life Time: 50,000Hrs

Optional Features

- Dimming(DALI/0-10V/1-10V/Phase Dimming)
- Emergency Back up

PRODUCT PARAMETERS

PHYSICAL	
Housing	Die-Cast Aluminum
Diffuser	Opal Polycarbonate
Finish	RAL 9016 / RAL 9005
Mounting	Recessed
OPTICAL	
Beam Angle	80°
UGR	--
ELECTRICAL	
CRI	≥80(≥90 upon Request)
CCT	3000K/4000K/6000K
Voltage / Frequency	220-240 VAC / 50-60Hz
Operating Temperature	--25°C to +45°C
Driver	Remote

PRODUCT DETAILS

Product Code	Wattage	Lumen	Cutout	Product Size
ELRD 1002-A	10W	800 lm	Ø82-88 mm	Ø95xH54 mm
ELRD 1002-B	13W	1040 lm	Ø90-95 mm	Ø110xH54 mm
ELRD 1002-C	18W	1750 lm	Ø125-135 mm	Ø145xH78 mm
ELRD 1002-D	25W	2100 lm	Ø125-135 mm	Ø145xH78 mm
ELRD 1002-E	35W	2800 lm	Ø150-165 mm	Ø172xH90 mm
ELRD 1002-F	40W	3200 lm	Ø200-210 mm	Ø228xH99 mm

PRODUCT DRAWING

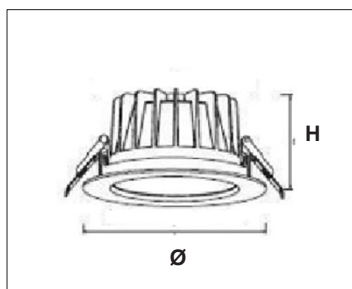

LIGHT DISTRIBUTION

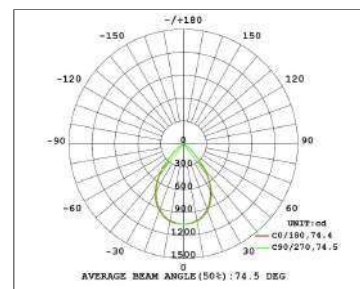

ELRD-1003

APPLICATIONS:

Offices, Meeting Rooms,
Schools, Retail Stores,
Libraries & Reading Areas

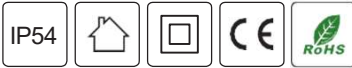

Features

- Higher Lumen efficiency 110 lm /W
- Rated Life Time: 50,000Hrs

Optional Features

- Dimming (DALI/0-10V/1-10V/Phase Dimming)
- Emergency Back up

PRODUCT PARAMETERS	
PHYSICAL	
Housing	Die-Cast Aluminum
Diffuser	Opal Polycarbonate
Finish	RAL 9016 / RAL 9005
Mounting	Recessed
OPTICAL	
Beam Angle	90°
UGR	--
ELECTRICAL	
CRI	80°(≥90 upon Request)
CCT	3000K/4000K/6000K
Voltage / Frequency	220-240 VAC / 50-60Hz
Operating Temperature	-25°C to +45°C
Driver	Remote

PRODUCT DETAILS

Product Code	Wattage	Lumen	Cutout	Product Size
ELRD 1003-A	9W	990 lm	90-100	Ø110xH42.2 mm
ELRD 1003-B	12W	1320 lm	90-100	Ø110xH42.2 mm
ELRD 1003-C	15W	1650 lm	145-150	Ø140xH53.3 mm
ELRD 1003-D	20W	2200 lm	165-175	Ø190xH76 mm
ELRD 1003-E	28W	3080 lm	200-210	Ø230xH88 mm

PRODUCT DRAWING

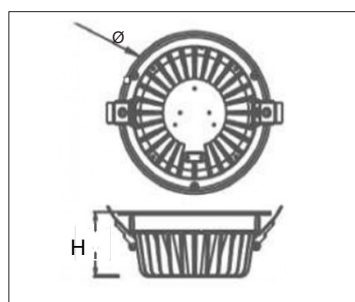

LIGHT DISTRIBUTION

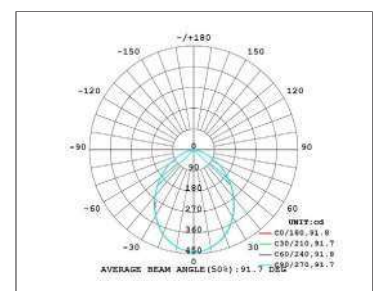

ELRD-1004

APPLICATIONS:

Offices, Meeting Rooms,
Schools, Retail Stores,
Libraries & Reading Areas

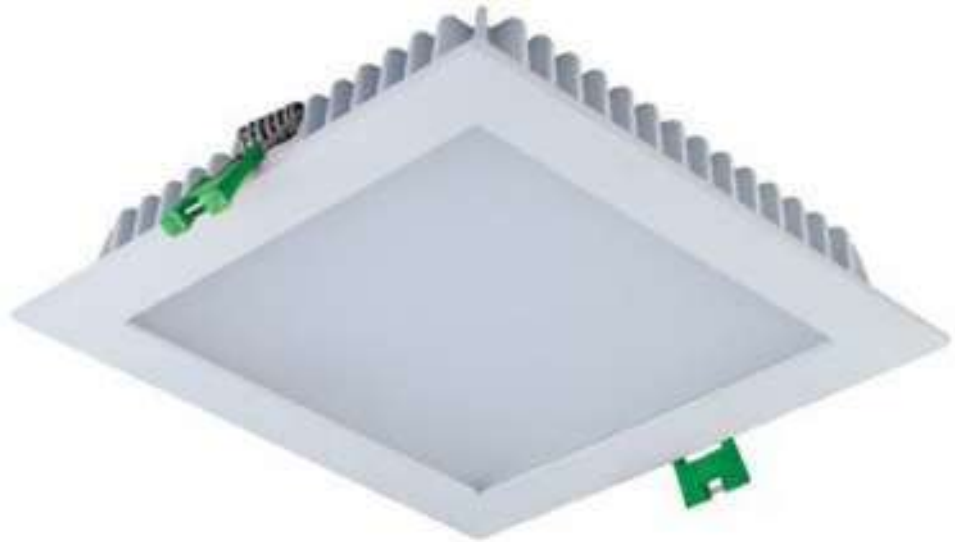
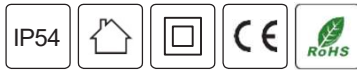

Features

- Higher Lumen efficiency 110 lm/W
- Rated Life Time: 50,000Hrs

Optional Features

- Dimming (DALI/0-10V/1-10V/Phase Dimming)
- Emergency Back UP

PRODUCT PARAMETERS

PHYSICAL	
Housing	Die-Cast Aluminum
Diffuser	Opal Polycarbonate
Finish	RAL 9016 / RAL 9005
Mounting	Recessed
OPTICAL	
Beam Angle	80°
UGR	--
ELECTRICAL	
CRI	≥80(≥90 upon Request)
CCT	3000K/4000K/6000K
Voltage / Frequency	220-240 VAC / 50-60Hz
Operating Temperature	--25°C to +45°C
Driver	Remote

PRODUCT DETAILS

Product Code	Wattage	Lumen	Cutout	Product Size
ELRD 1004-A	9W	990 lm	110-115 mm	□125xH25 mm
ELRD 1004-B	15W	1550 lm	125-130 mm	□140xH25 mm
ELRD 1004-C	20W	2200 lm	140-145 mm	□160xH26 mm

PRODUCT DRAWING

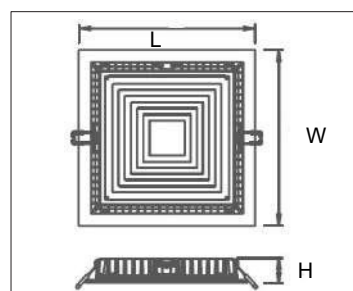

LIGHT DISTRIBUTION

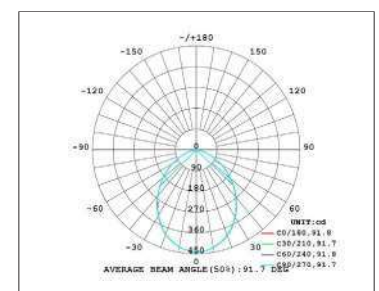

ELRD-1005

APPLICATIONS:

Offices, Meeting Rooms,
Schools, Retail Stores,
Libraries & Reading Areas

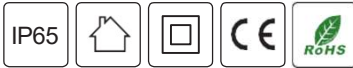

Features

- Higher Lumen efficiency 110 lm/W
- Rated Life Time: 50,000Hrs

Optional Features

- Dimming (DALI/0-10V/1-10V/Phase Dimming)
- Emergency Back up

PRODUCT PARAMETERS

PHYSICAL	
Housing	Die-Cast Aluminum
Diffuser	Clear Glass
Finish	RAL 9016 / RAL 9005
Mounting	Recessed
OPTICAL	
Beam Angle	20°/40°/60°
UGR	--
ELECTRICAL	
CRI	≥90
CCT	3000K/4000K/6000K
Voltage / Frequency	220-240 VAC / 50-60Hz
Operating Temperature	-25°C to +45°C
Driver	Remote

PRODUCT DETAILS

Product Code	Wattage	Lumen	Cutout	Product Size
ELRD 1005-A	10W	1100 lm	Ø75 mm	Ø88xH62 mm
ELRD 1005-B	12W	1320 lm	Ø75mm	Ø88xH62 mm
ELRD 1005-C	15W	1650 lm	Ø95mm	Ø155xH74 mm
ELRD 1005-D	18W	1980 lm	Ø95mm	Ø155xH74 mm
ELRD 1005-E	30W	3300 lm	Ø125 mm	Ø142xH86 mm
ELRD 1005-F	40W	4400 lm	Ø145 mm	Ø164xH98 mm

PRODUCT DRAWING

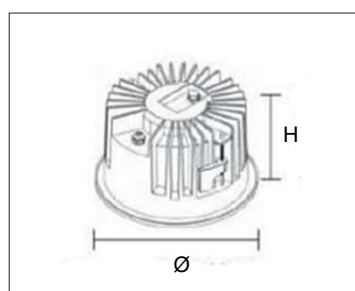

LIGHT DISTRIBUTION

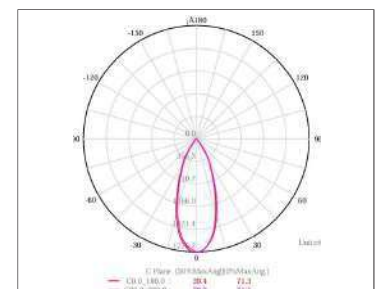



LED SPOT LIGHT SERIES

LED Spot Light Series is designed to deliver precise, high-intensity lighting that enhances architectural features, highlights focal points, and creates dramatic visual effects. Whether for retail displays, art galleries, hotels, or residential settings, these spotlights provide brilliant, directional illumination with energy-saving benefits and long-lasting reliability. Available in multiple beam angles, wattages, and color temperatures, this series offers flexibility and performance without compromising on aesthetics.



ELDLD-1227



ELLM



ELDLD-1050



ELDLD-1051



ELDLD-1052



ELDLD-1053



ELDLD-1054

ELDL-1227



APPLICATIONS:
Offices, Meeting Rooms,
Schools & Art Gallery

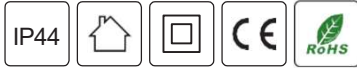

Features

- Higher Lumen efficiency 100 lm/W
- Rated Life Time: 50,000Hrs

Optional Features

- Dimming(DALI/0-10V/1-10V/Phase Dimming)
- Emergency Back up

PRODUCT PARAMETERS

PHYSICAL	
Housing	Die-Cast Aluminium
Diffuser	Clear Glass
Finish	RAL 9016 / RAL 9005
Mounting	Recessed
OPTICAL	
Beam Angle	24°
UGR	--
ELECTRICAL	
CRI	≥80(≥90 upon Request)
CCT	3000K/4000K/6000K
Voltage / Frequency	220-240 VAC / 50-60Hz
Operating Temperature	-25°C to +45°C
Driver	Remote

PRODUCT DETAILS

Product Code	Wattage	Lumen	Cutout	Product Size
ELDL 1227	5W	500lm	55 mm	Ø65xH70 mm
	7W	700 lm	75 mm	Ø85xH85 mm
	10W	1000 lm	75 mm	Ø85xH85 mm
	12W	1200 lm	110 mm	Ø120xH105 mm

PRODUCT DRAWING

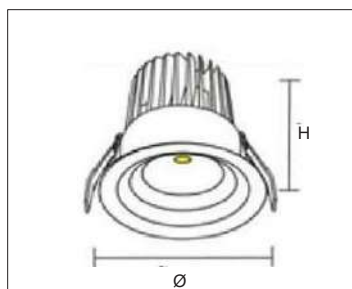

LIGHT DISTRIBUTION

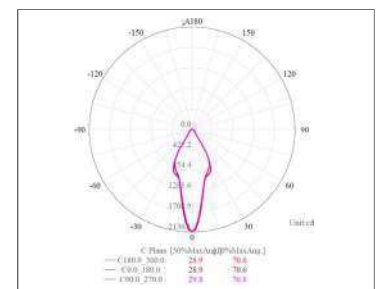

APPLICATIONS:
Offices, Meeting Rooms,
Schools & Art Gallery



Features

- Higher Lumen efficiency 110 lm/W
- Rated Life Time: 50,000Hrs

Optional Features

- Dimming(DALI/0-10V/1-10V/Phase Dimming)
- Emergency Back up
- IP54 Available upon Request

PRODUCT PARAMETERS

PHYSICAL	
Housing	Die-Cast Aluminium
Diffuser	Opal – Polycarbonate Centre Frosted/Clear -Glass
Finish	RAL 9016 / RAL 9005
Mounting	Recessed
OPTICAL	
Beam Angle	24°/36°
UGR	--
ELECTRICAL	
CRI	≥90
CCT	3000K/4000K/6000K
Voltage / Frequency	220-240 VAC / 50-60Hz
Operating Temperature	--25°C to +45°C
Driver	Remote

PRODUCT DETAILS

Product Code	Wattage	Lumen	Cutout	Product Size
ELLM 1487	7W	770 lm	75 mm	Ø85xH78 mm
ELLM 1488	12W	1320 lm	95 mm	Ø110xH90 mm

PRODUCT DRAWING

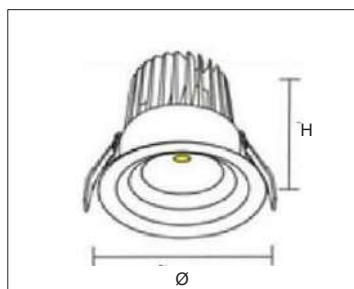

LIGHT DISTRIBUTION

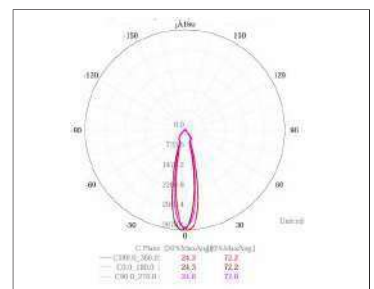

ELDL-1050



APPLICATIONS:
Offices, Meeting Rooms,
Schools & Art Gallery



Features

- Higher Lumen efficiency 110 lm/W
- Rated Life Time: 50,000Hrs
- Multiple Reflector Option

Optional Features

- Dimming(DALI/0-10V/1-10V/Phase Dimming)
- Emergency Back up

PRODUCT PARAMETERS

PHYSICAL	
Housing	Die-Cast Aluminium
Diffuser	Polycarbonate Lens
Finish	RAL 9016 / RAL 9005
Mounting	Recessed
OPTICAL	
Beam Angle	15°/24°/36°
UGR	--
ELECTRICAL	
CRI	≥90
CCT	3000K/4000K/6000K
Voltage / Frequency	220-240 VAC / 50-60Hz
Operating Temperature	-25°C to +45°C
Driver	Remote

PRODUCT DETAILS

Product Code	Wattage	Lumen	Product Size
ELDL 1050-A	10W	1100 lm	Ø85xH96 mm
ELDL 1050-B	12W	1320 lm	Ø85xH96 mm
ELDL 1050-C	10W	1100 lm	□75xH100 mm
ELDL 1050-D	12W	1320 lm	□75xH100 mm

PRODUCT DRAWING

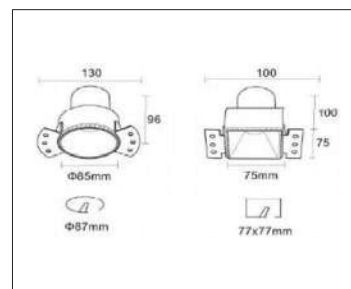

LIGHT DISTRIBUTION

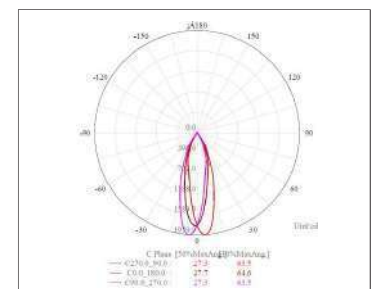

ELDL-1051

APPLICATIONS:
Offices, Meeting Rooms,
Schools & Art Gallery



Features

- Higher Lumen efficiency 110 lm/W
- Rated Life Time: 50,000Hrs
- Multiple Reflector Option

Optional Features

- Dimming(DALI/0-10V/1-10V/Phase Dimming)

PRODUCT PARAMETERS

PHYSICAL	
Housing	Die-Cast Aluminium
Diffuser	Polycarbonate Lens
Finish	RAL 9016 / RAL 9005
Mounting	Recessed
OPTICAL	
Beam Angle	24°/36°/55°
UGR	<19
ELECTRICAL	
CRI	≥90
CCT	3000K/4000K/6000K
Voltage / Frequency	220-240 VAC / 50-60Hz
Operating Temperature	-25°C to +45°C
Driver	Remote

PRODUCT DETAILS

Product Code	Wattage	Lumen	Cutout	Product Size
ELDL 1051-A	7W	770 lm	75 mm	Ø85xH62 mm
ELDL 1051-B	10W	1100 lm	75 mm	Ø85xH62 mm
ELDL 1051-C	12W	1320 lm	95 mm	Ø105xH77 mm
ELDL 1051-D	7W	770 lm	75 mm	□85xH62 mm
ELDL 1051-E	10W	1100 lm	75 mm	□85xH62 mm
ELDL 1051-F	12W	1320 lm	95 mm	□105xH77 mm

PRODUCT DRAWING

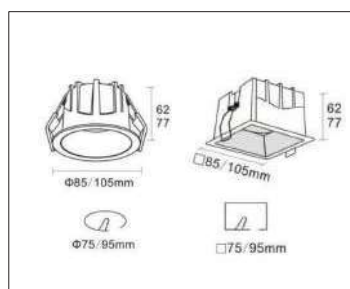

LIGHT DISTRIBUTION

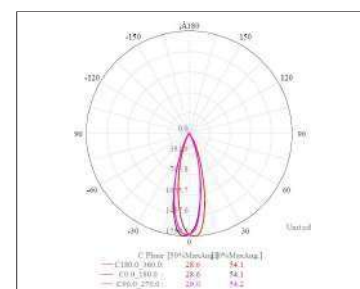

ELDL-1052



APPLICATIONS:
Offices, Meeting Rooms,
Schools & Art Gallery

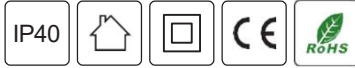

Features

- Higher Lumen efficiency 110 lm/W
- Rated Life Time: 50,000Hrs
- Trim less-Recessed

Optional Features

- Dimming(DALI/0-10V/1-10V/Phase Dimming)
- Emergency Back up

PRODUCT PARAMETERS

PHYSICAL	
Housing	Die-Cast Aluminium
Diffuser	Polycarbonate Lens
Finish	RAL 9016 / RAL 9005
Mounting	Recessed
OPTICAL	
Beam Angle	15°/24°/38°/50°
UGR	--
ELECTRICAL	
CRI	≥90
CCT	3000K/4000K/6000K
Voltage / Frequency	220-240 VAC / 50-60Hz
Operating Temperature	--25°C to +45°C
Driver	Remote

PRODUCT DETAILS

Product Code	Wattage	Lumen	Cutout	Product Size
ELDL 1052-A	1x3W	390 lm	45x45 mm	L55xW55xH45 mm
ELDL 1052-B	3x3W	1000 lm	125x50 mm	L130xW55xH46 mm
ELDL 1052-C	5x3W	1650 lm	200x50 mm	L205xW55xH46 mm
ELDL 1052-D	10x2W	2200 lm	390x50 mm	L395xW55xH46 mm
ELDL 1052-E	10x3W	3300 lm	390x50 mm	L395xW55xH46 mm
ELDL 1052-F	15x2W	3300 lm	585x50 mm	L590xW55xH46 mm

PRODUCT DRAWING

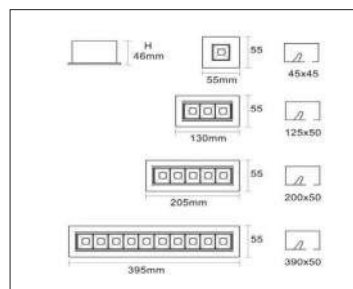

LIGHT DISTRIBUTION

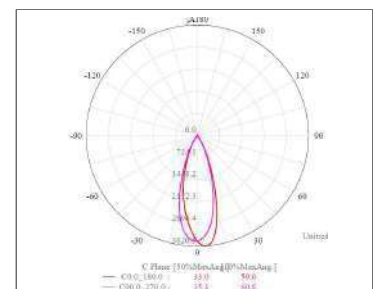

ELDL-1053



APPLICATIONS:
Offices, Meeting Rooms,
Schools & Art Gallery

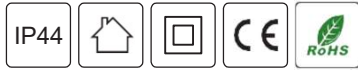

Features

- Higher Lumen efficiency 110 lm/W
- Rated Life Time: 50,000Hrs
- Adjustable

Optional Features

- Dimming(DALI/0-10V/1-10V/Phase Dimming)
- Modular design supports single, dual or triple-frame setups
- Emergency Back up

PRODUCT PARAMETERS

PHYSICAL	
Housing	Die-Cast Aluminium
Diffuser	Tempered Glass
Finish	RAL 9016 / RAL 9005
Mounting	Recessed
OPTICAL	
Beam Angle	15°/24°/38°/60°
UGR	--
ELECTRICAL	
CRI	≥90
CCT	3000K/4000K/6000K
Voltage / Frequency	220-240 VAC / 50-60Hz
Operating Temperature	-25°C to +45°C
Driver	Remote

PRODUCT DETAILS

Product Code	Wattage	Lumen	Cutout	Product Size
ELDL 1053-A	7W	770 lm	75mm	Ø 85xH68 mm
ELDL 1053-B	12W	1320 lm	85mm	Ø100xH88 mm
ELDL 1053-C	20W	2200 lm	120mm	Ø 140xH102 mm
ELDL 1053-D	30W	3300 lm	150mm	Ø 175xH116 mm
ELDL 1053-E	7W	770 lm	75mm	□85xH68 mm
ELDL 1053-F	12W	1320 lm	85mm	□100xH88 mm
ELDL 1053-G	20W	2200 lm	120mm	□140xH102 mm
ELDL 1053-H	30W	3300 lm	150mm	□175xH116 mm

PRODUCT DRAWING

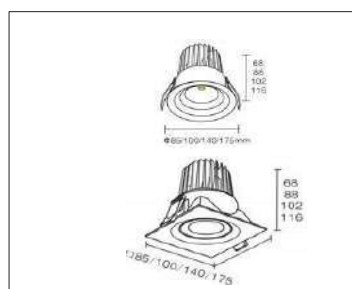

LIGHT DISTRIBUTION

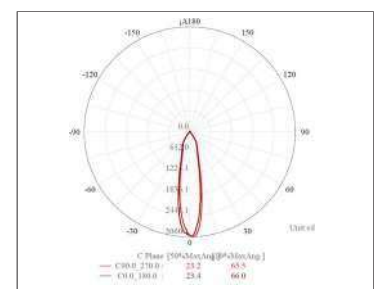

ELDL-1054



APPLICATIONS:
Offices, Meeting Rooms,
Schools & Art Gallery

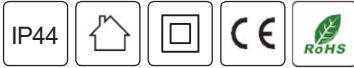

Features

- Higher Lumen efficiency 110 lm/W
- Rated Life Time: 50,000Hrs
- Multi Recessed
- Various Wattage Available

Optional Features

- Dimming(DALI/0-10V/1-10V/Phase Dimming)
- Emergency Back up

PRODUCT PARAMETERS

PHYSICAL	
Housing	Die-Cast Aluminium
Diffuser	Tempered Glass
Finish	RAL 9016 / RAL 9005
Mounting	Recessed
OPTICAL	
Beam Angle	15°/24°/38°/60°
UGR	--
ELECTRICAL	
CRI	≥90
CCT	3000K/4000K/6000K
Voltage / Frequency	220-240 VAC / 50-60Hz
Operating Temperature	-25°C to +45°C
Driver	Remote

PRODUCT DETAILS

Product Code	Wattage	Lumen	Cutout	Product Size
ELDL 1054-A	1x12W	1320 lm	117x117 mm	L137xW137xH80 mm
ELDL 1054-B	1x18W	1960 lm	117x117 mm	L137xW137xH110 mm
ELDL 1054-C	1x30W	3300 lm	117x117 mm	L137xW137xH130 mm
ELDL 1054-D	2x12W	2640 lm	230x137 mm	L250xW137xH80 mm
ELDL 1054-E	2x18W	3920 lm	230x137 mm	L250xW137xH110 mm
ELDL 1054-F	2x30W	6600 lm	230x137 mm	L250xW137xH130 mm
ELDL 1054-G	3x12W	3960 lm	342x117 mm	L362xW137xH80 mm
ELDL 1054-H	3x18W	5880 lm	342x117 mm	L362xW137xH110 mm
ELDL 1054-I	3x30W	9990 lm	342x117 mm	L362xW137xH130 mm

PRODUCT DRAWING

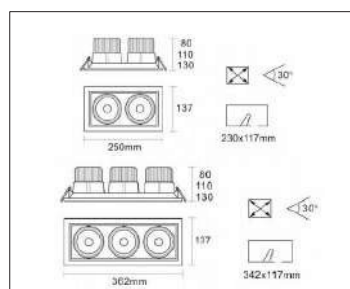

LIGHT DISTRIBUTION

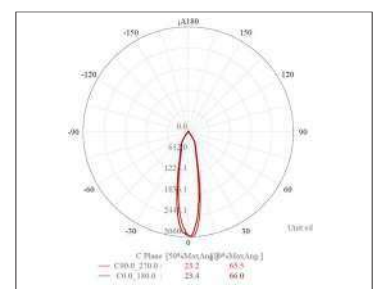





LED CEILING LIGHT SERIES

LED Ceiling Light Series brings together modern design and reliable performance to create lighting that enhances any space—residential or commercial. Designed for surface mounting on ceilings or walls, these lights offer soft, uniform brightness that's both functional and stylish. Built with high-efficiency LED technology, this series delivers long-lasting illumination with minimal energy consumption, making it a smart, eco-friendly alternative to traditional lighting.



ESRO



ESRO-2001

ESRO



APPLICATIONS:

Residential Spaces, Commercial Spaces, Art Galleries, Museums & Retail Stores



Features

- Higher Lumen efficiency 110 lm/W
- Rated Life Time: 50,000 Hrs

Optional Features

- Dimming(DALI/0-10V/1-10V/Phase Dimming)
- IP 44 Available upon Request

PRODUCT PARAMETERS

PHYSICAL	
Housing	Die Cast Aluminum
Diffuser	Opal Polycarbonate
Finish	RAL 9016 / RAL 9005
Mounting	Surface Mount
OPTICAL	
Beam Angle	110°
UGR	--
ELECTRICAL	
CRI	≥90
CCT	3000K/4000K/6000K
Voltage / Frequency	220-240 VAC / 50-60Hz
Operating Temperature	-20°C to +50°C
Driver	Remote

PRODUCT DETAILS

Product Code	Wattage	Lumen	Product Size
ESRO	12W	1320 lm	Ø120xH39 mm
	20W	2200 lm	Ø175xH39 mm
	22W	2420 lm	Ø225xH39 mm
	24W	2640 lm	Ø300xH39 mm

PRODUCT DRAWING

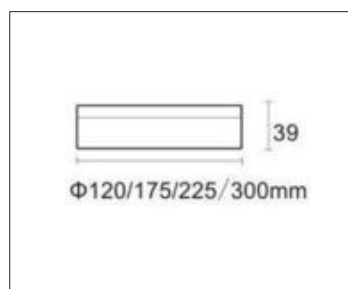

LIGHT DISTRIBUTION

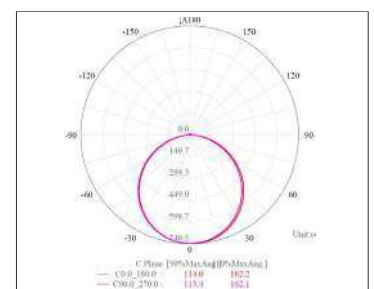

ESRO-2001

APPLICATIONS:

Residential Spaces, Commercial Spaces, Art Galleries, Museums & Retail Stores

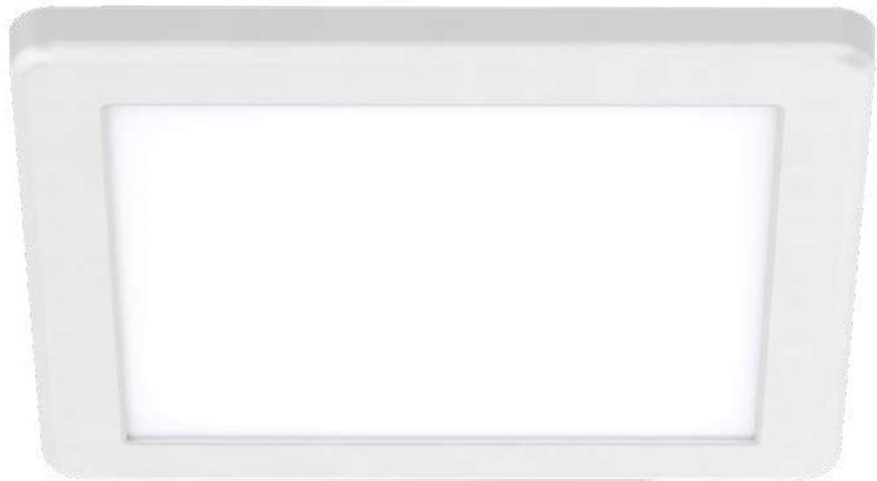
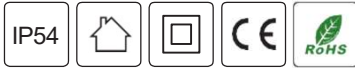

Features

- Higher Lumen efficiency 110 lm/W
- Rated Life Time: 50,000 Hrs

Optional Features

- Microwave Sensor
- CCT Changeable
- Emergency
- Dimming(DALI/0-10V/1-10V/Phase Dimming)

PRODUCT PARAMETERS

PHYSICAL	
Housing	Polycarbonate
Diffuser	Polycarbonate
Finish	RAL 9016
Mounting	Surface Mount
OPTICAL	
Beam Angle	110°
UGR	--
ELECTRICAL	
CRI	≥80
CCT	3000K/4000K/6000K
Voltage / Frequency	220-240 VAC / 50-60Hz
Operating Temperature	-20°C to +50°C
Driver	Remote

PRODUCT DETAILS

Product Code	Wattage	Lumen	Product Size
ESRO 2001-A	10/15W	1150/1650 lm	□250xH52 mm
ESRO 2001-B	18/25W	2060/2850 lm	□300xH52 mm
ESRO 2001-C	30W	3650 lm	□400xH52 mm

PRODUCT DRAWING

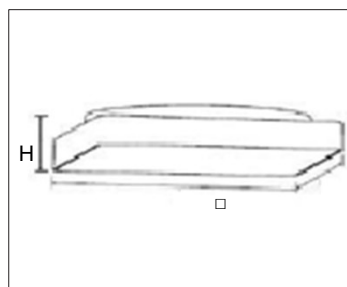

LIGHT DISTRIBUTION

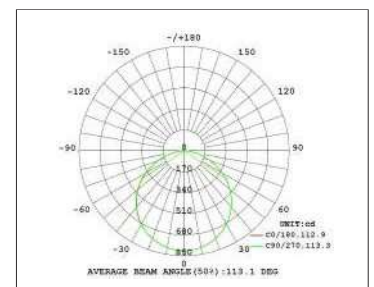



SURFACE DOWNLIGHT SERIES

Surface Mounted Downlight Series delivers the elegant look and performance of recessed lighting—without the need for cutouts or false ceilings. Designed for quick mounting on solid surfaces, these downlights are ideal for both retrofit and new-build applications where recessed fixtures aren't feasible.

With sleek housing, uniform light distribution, and high energy efficiency, this series is perfect for commercial, retail, and residential spaces that demand style, simplicity, and function in one.



ELSD-3020



ELSD-3030



ELSD-3040

ELSD-3020



APPLICATIONS:

Residential Spaces, Commercial Spaces, Art Galleries, Museums & Retail Stores



Features

- Higher Lumen efficiency 110 lm/W
- Rated Life Time: 50,000 Hrs

Optional Features

- Dimming(DALI/0-10V/1-10V/Phase Dimming)

PRODUCT PARAMETERS

PHYSICAL	
Housing	Die-Cast Aluminium
Diffuser	Clear Glass
Finish	RAL 9016/ RAL 9005
Mounting	Surface Mount
OPTICAL	
Beam Angle	20°/40°/60°
UGR	<16
ELECTRICAL	
CRI	≥90
CCT	3000K/4000K/6000K
Voltage / Frequency	220-240 VAC / 50-60Hz
Operating Temperature	-20°C to +50°C
Driver	In Built

PRODUCT DETAILS

Product Code	Wattage	Lumen	Product Size
ELSD 3020 -1A	10W	1100 lm	Ø90xH90 mm
ELSD 3020-1B	15W	1650 lm	Ø110xH110 mm
ELSD 3020-1C	18W	1980 lm	Ø130xH130 mm
ELSD 3020-1D	25W	2750 lm	Ø170xH170 mm
ELSD 3020-1F	30W	3300 lm	Ø170xH170 mm
ELSD 3020-1G	40W	4400 lm	Ø195xH190 mm
ELSD 3020-2A	10W	1100 lm	□90xH90 mm
ELSD 3020-2B	15W	1650 lm	□110xH110 mm
ELSD 3020-2C	18W	1980 lm	□110xH110 mm

PRODUCT DRAWING

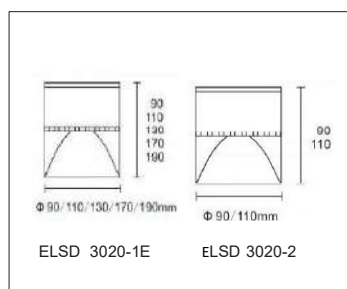

LIGHT DISTRIBUTION

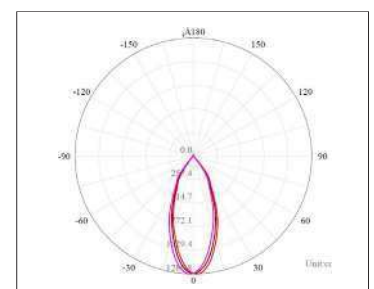

ELSD-3030



APPLICATIONS:

Residential Spaces, Commercial Spaces, Art Galleries, Museums & Retail Stores



Features

- Higher Lumen efficiency 110 lm/W
- Rated Life Time: 50,000 Hrs
- Multiple Mounting Methods

Optional Features

- Dimming(DALI/0-10V/1-10V/Phase Dimming)

PRODUCT PARAMETERS

PHYSICAL	
Housing	Die Cast Aluminum
Diffuser	Tempered Glass
Finish	RAL 9016/ RAL 9005
Mounting	Surface Mount/Suspended
OPTICAL	
Beam Angle	24°/36°/60°
UGR	<19(24°/36°), <22(60°)
ELECTRICAL	
CRI	≥80(>90 Upon Request)
CCT	3000K/4000K/6000K
Voltage / Frequency	220-240 VAC / 50-60Hz
Operating Temperature	-20°C to +50°C
Driver	In Built

PRODUCT DETAILS

Product Code	Wattage	Lumen	Product Size
ELSD 30301A/2A	6W	600 lm	A55xB160/A55xB1189xC160xD1000xE105 mm
ELSD 30301B/2B	10W	1000 lm	A55xB160/A55xB1189xC160xD1000xE105 mm
ELSD 30301C/2C	15W	1550 lm	A65xB180/A65xB1209xC180xD1000xE105 mm
ELSD 30301D/2D	20W	2300 lm	A85xB206/A85xB1235xC206xD1000xE105 mm
ELSD 30301E/2E	25W	2850 lm	A85xB206/A85xB1235xC206xD1000xE105 mm
ELSD 30301F/2F	30W	3300 lm	A100xB220/A100xB1249xC220xD1000xE105 mm
ELSD 30301G/2G	35W	3800 lm	A100xB220/A100xB1249xC220xD1000xE105 mm

PRODUCT DRAWING

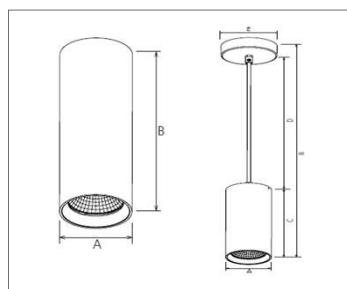

LIGHT DISTRIBUTION

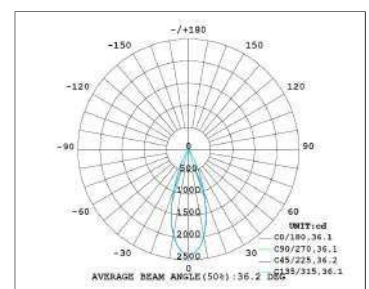

ELSD-3040



APPLICATIONS:

Residential Spaces, Commercial Spaces, Art Galleries, Museums & Retail Stores



Features

- Higher Lumen efficiency 110 lm/W
- Rated Life Time: 50,000 Hrs

Optional Features

- Dimming(DALI/0-10V/1-10V/Phase Dimming)

PRODUCT PARAMETERS

PHYSICAL	
Housing	Die-Cast Aluminium
Diffuser	Clear Glass
Finish	RAL 9016 / RAL 9005
Mounting	Surface Mounted
OPTICAL	
Beam Angle	45°/60°
UGR	--
ELECTRICAL	
CRI	≥90
CCT	3000K/4000K/6000K
Voltage / Frequency	220-240 VAC / 50-60Hz
Operating Temperature	-20°C to +50°C
Driver	In Built

PRODUCT DETAILS

Product Code	Wattage	Lumen	Product Size
ELSD 3040-A	10W	1100 lm	Ø110XH120 mm
ELSD 3040-B	15W	1650lm	Ø130XH155 mm
ELSD 3040-C	20W	2200lm	Ø130XH155 mm
ELSD 3040-D	30W	3300 lm	Ø170XH185 mm
ELSD 3040-E	40W	4400 lm	Ø193xH195 mm

PRODUCT DRAWING

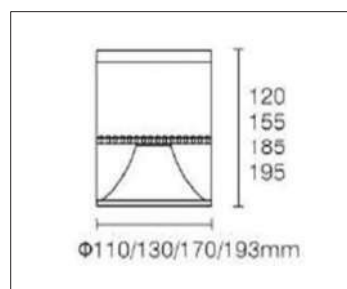

LIGHT DISTRIBUTION

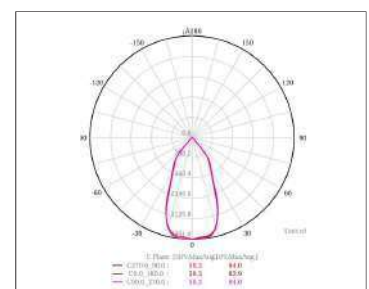





LED WALL LIGHT SERIES

LED Wall Light Series combines timeless design with modern LED technology to enhance interiors and exteriors with both ambiance and efficiency. Whether used as a decorative accent, task lighting, or pathway illumination, these wall lights offer soft, directional lighting with reduced energy consumption and a long operational life.



ELPE-OD



ESDAO



ELWL-1502



ELWL-1503



ELWL-1504



ELWL-1505



ELWL-1506



ELWL-1507



ELWL-1508



ELWL-1509

ELPE-OD



APPLICATIONS:

Outdoor Residential Building,
Commercial Spaces, Industrial
Spaces, Hospitality & Retail



Features

- Higher Lumen efficiency 130 lm/W
- Rated Life Time: 50,000 Hrs

Optional Features

- Dimming(DALI/1-10V)
- Emergency Back up

PRODUCT PARAMETERS

PHYSICAL	
Housing	Die-Cast Aluminum
Diffuser	Tempered Prismatic Glass
Finish	RAL 8019
Mounting	Wall Mount
OPTICAL	
Beam Angle	120°
UGR	--
ELECTRICAL	
CRI	≥80
CCT	3000K/4000K/6000K
Voltage / Frequency	220-240 VAC / 50-60Hz
Operating Temperature	-20°C to +50°C
Driver	In Built

PRODUCT DETAILS

Product Code	Wattage	Lumen	Product Size
ELPE OD	32W	4160 lm	L362xW235xH182mm
	45W	5850 lm	L362xW235xH182mm
	50W	6500 lm	L362xW235xH182mm
	65W	8450 lm	L362xW235xH182mm

PRODUCT DRAWING

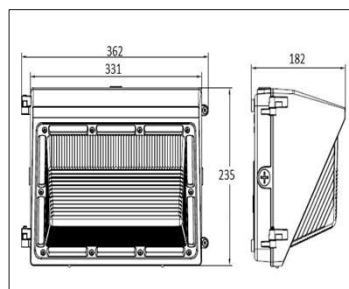

LIGHT DISTRIBUTION

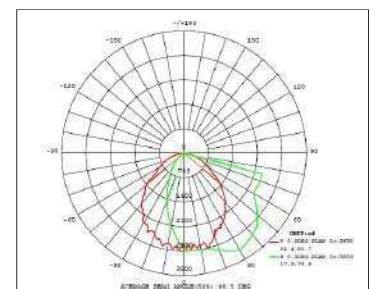

ESDAO



APPLICATIONS:

Outdoor Residential Building,
Commercial Spaces, Industrial
Spaces, Hospitality & Retail

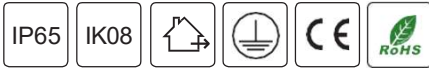

Features

- Higher Lumen efficiency 100lm/W
- Rated Life Time: 50,000 Hrs

Optional Features

- Dimming(DALI/1-10V)
- Emergency Back up

PRODUCT PARAMETERS

PHYSICAL	
Housing	Die-Cast Aluminum
Diffuser	Opal Polycarbonate
Finish	RAL9003/9005/9006/ 9010/9016
Mounting	Surface Mount
OPTICAL	
Beam Angle	120°
UGR	--
ELECTRICAL	
CRI	≥80
CCT	3000K/4000K/6000K
Voltage / Frequency	220-240 VAC / 50-60Hz
Operating Temperature	-20°C to +50°C
Driver	In Built

PRODUCT DETAILS

Product Code	Wattage	Lumen	Product Size
ESDAO	12W	1200 lm	Ø220xH85mm
	16W	1600 lm	Ø275xH85mm
	24W	2400 lm	Ø300xH85mm
	30W	3000 lm	Ø360xH85mm

PRODUCT DRAWING

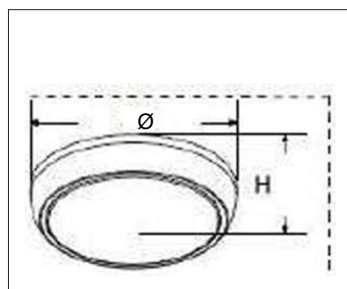

LIGHT DISTRIBUTION

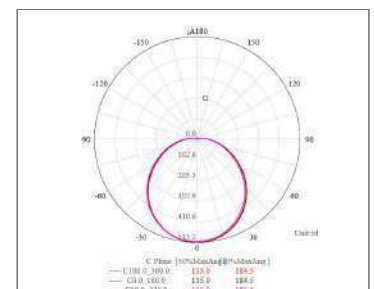

ELWL-1502



APPLICATIONS:

Outdoor Residential Building,
Commercial Spaces, Industrial
Spaces, Hospitality & Retail

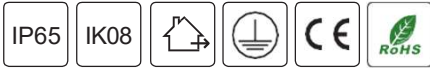

Features

- Higher Lumen efficiency 110 lm/W
- Rated Life Time: 50,000 Hrs

Optional Features

- Dimming(DALI/1-10V)

PRODUCT PARAMETERS

PHYSICAL	
Housing	Die cast Aluminum
Diffuser	Tempered glass
Finish	RAL 9007 / RAL 9005
Mounting	Wall Mount
OPTICAL	
Beam Angle	80°
UGR	--
ELECTRICAL	
CRI	≥90
CCT	3000K/4000K/6000K
Voltage / Frequency	220-240 VAC / 50-60Hz
Operating Temperature	-20°C to +50°C
Driver	In Built

PRODUCT DETAILS

Product Code	Wattage	Lumen	Product Size
ELWL 1502-A	20W	2100 lm	L199xW168xH107mm
ELWL 1502-B	30W	3150 lm	L199xW168xH107mm
ELWL 1502-C	50W	5250 lm	L298xW242xH163mm
ELWL 1502-D	70W	7350 lm	L298xW242xH163mm

PRODUCT DRAWING

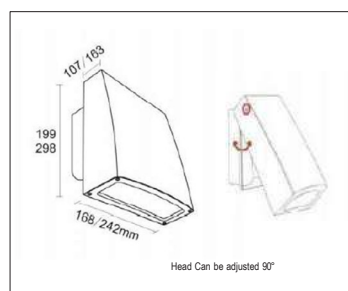

LIGHT DISTRIBUTION

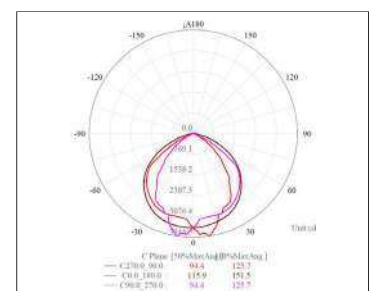

ELWL-1503



APPLICATIONS:

Outdoor Residential Building,
Commercial Spaces, Industrial
Spaces, Hospitality & Retail

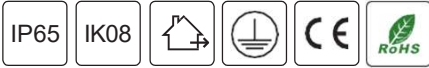

Features

- Higher Lumen efficiency 110 lm/W
- Rated Life Time: 50,000 Hrs

Optional Features

- Dimming(DALI/1-10V)

PRODUCT PARAMETERS

PHYSICAL	
Housing	Die cast Aluminum
Diffuser	Tempered Glass
Finish	RAL 9007 / RAL 9005
Mounting	Wall Mount
OPTICAL	
Beam Angle	120°
UGR	--
ELECTRICAL	
CRI	≥90
CCT	3000K/4000K/6000K
Voltage / Frequency	220-240 VAC / 50-60Hz
Operating Temperature	-20°C to +50°C
Driver	In Built

PRODUCT DETAILS

Product Code	Wattage	Lumen	Product Size
ELWL 1503-A	10W	1100 lm	L125xW120xH120 mm
ELWL 1503-B	15W	1650 lm	L150xW145xH155mm
ELWL 1503-C	10W	1100 lm	L125xW120xH120mm
ELWL 1503-D	15W	1650 lm	L150xW145xH155mm

PRODUCT DRAWING

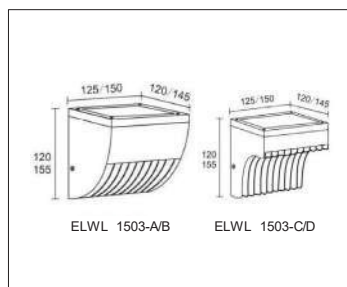

LIGHT DISTRIBUTION

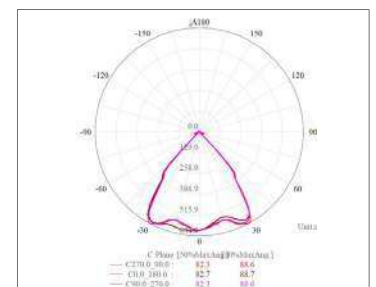

ELWL-1504

APPLICATIONS:

Outdoor Residential Building,
Commercial Spaces, Industrial
Spaces, Hospitality & Retail

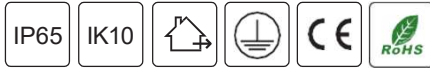

Features

- Higher Lumen efficiency 100 lm/W
- Rated Life Time: 50,000 Hrs

Optional Features

- Dimming(DALI/1-10V)

PRODUCT PARAMETERS

PHYSICAL	
Housing	Die-Cast Aluminum
Diffuser	Opal Polycarbonate
Finish	RAL 9007 / RAL 9005
Mounting	Wall Mount
OPTICAL	
Beam Angle	120°
UGR	--
ELECTRICAL	
CRI	≥90
CCT	3000K/4000K/6000K
Voltage / Frequency	220-240 VAC / 50-60Hz
Operating Temperature	-20°C to +50°C
Driver	In Built

PRODUCT DETAILS

Product Code	Wattage	Lumen	Product Size
ELWL 1504-1A	24W	2400 lm	□300xH77mm
ELWL 1504-1B	32W	3200 lm	□360xH113mm
ELWL 1504-1C	40W	4000 lm	□360xH113mm
ELWL 1504-2A	24W	2400 lm	□300xH87mm
ELWL 1504-2B	32W	3200 lm	□360xH125mm
ELWL 1504-2C	40W	4000 lm	□360xH125mm
ELWL 1504-3A	24W	2400 lm	□300xH87mm
ELWL 1504-3B	32W	3200 lm	□360xH125mm
ELWL 1504-3C	40W	4000 lm	□360xH125mm

PRODUCT DRAWING

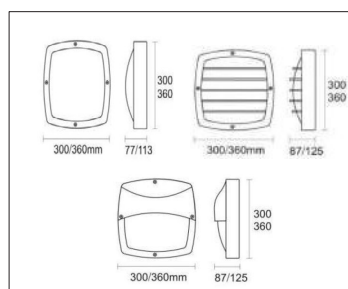

LIGHT DISTRIBUTION

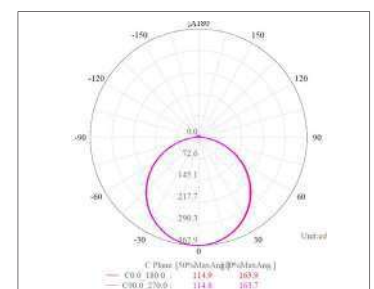

ELWL-1505



APPLICATIONS:

Outdoor Residential Building,
Commercial Spaces, Industrial
Spaces, Hospitality & Retail

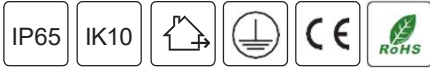

Features

- Higher Lumen efficiency 100 lm/W
- Rated Life Time: 50,000 Hrs

Optional Features

- Dimming(DALI/1-10V)

PRODUCT PARAMETERS

PHYSICAL	
Housing	Die-Cast Aluminum
Diffuser	Opal Polycarbonate Diffuser
Finish	RAL 9007 / RAL 9005 / RAL 9016
Mounting	Wall Mount
OPTICAL	
Beam Angle	120°
UGR	--
ELECTRICAL	
CRI	≥90
CCT	3000K/4000K/6000K
Voltage / Frequency	220-240 VAC / 50-60Hz
Operating Temperature	-20°C to +50°C
Driver	In Built

PRODUCT DETAILS

Product Code	Wattage	Lumen	Product Size
ELWL 1505-1A	12W	1200 lm	L220xW135xH55mm
ELWL 1505-1B	16W	1600 lm	L280xW185xH85mm
ELWL 1505-1C	24W	2400 lm	L345xW213xH95mm
ELWL 1505-2A	12W	1200 lm	L220xW135xH65mm
ELWL 1505-2B	16W	1600 lm	L280xW185xH95mm
ELWL 1505-2C	24W	2400 lm	L345xW213xH115mm
ELWL 1505-3A	12W	1200 lm	L220xW135xH65mm
ELWL 1505-3B	16W	1600 lm	L280xW185xH95mm
ELWL 1505-3C	24W	2400 lm	L345xW213xH105mm

PRODUCT DRAWING

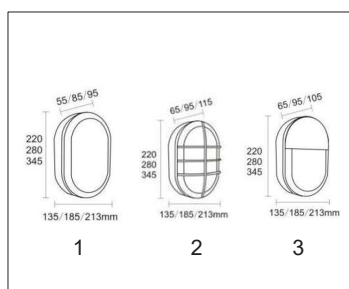

LIGHT DISTRIBUTION

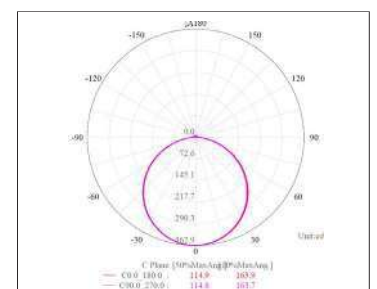

ELWL-1506



APPLICATIONS:

Outdoor Residential Building,
Commercial Spaces, Industrial
Spaces, Hospitality & Retail

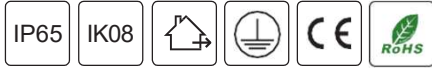

Features

- Rated Life Time: 50,000 Hrs

Optional Features

- Dimming(DALI/1-10V)

PRODUCT PARAMETERS

PHYSICAL	
Housing	Die-Cast Aluminum
Diffuser	Opal Polycarbonate
Finish	RAL 9005 / RAL 9007 / RAL 9016
Mounting	Wall Mount
OPTICAL	
Beam Angle	120°
UGR	--
ELECTRICAL	
CRI	≥80
CCT	3000K/4000K/6000K
Voltage / Frequency	220-240 VAC / 50-60Hz
Operating Temperature	-20°C to +50°C
Driver	In Built

PRODUCT DETAILS

Product Code	Wattage	Product Size
ELWL 1506	12W	Ø275xH75mm
	16W	Ø275xH75mm
	20W	Ø275xH75mm
	24W	Ø360xH75mm
	30W	Ø360xH75mm

PRODUCT DRAWING

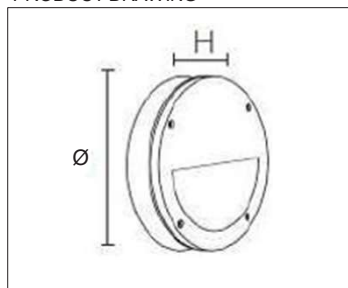

LIGHT DISTRIBUTION

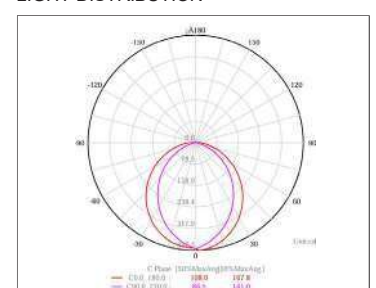

ELWL-1507



APPLICATIONS:

Outdoor Residential Building,
Parking Area, Industrial Spaces
& Petrol Station

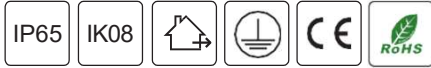

Features

- Higher Lumen efficiency 100 lm/W
- Rated Life Time: 50,000 Hrs

Optional Features

- Dimming(DALI/1-10V)

PRODUCT PARAMETERS

PHYSICAL	
Housing	Die-Cast Aluminum
Diffuser	Frosted Glass
Finish	RAL9007 / RAL9005 / RAL9016
Mounting	Wall Mount
OPTICAL	
Beam Angle	120°
UGR	--
ELECTRICAL	
CRI	≥90
CCT	3000K/4000K/6000K
Voltage / Frequency	220-240 VAC / 50-60Hz
Operating Temperature	-20°C to +50°C
Driver	In Built

PRODUCT DETAILS

Product Code	Wattage	Lumen	Product Size
ELWL 1507-A	6W	600 lm	Ø160xH95mm

PRODUCT DRAWING

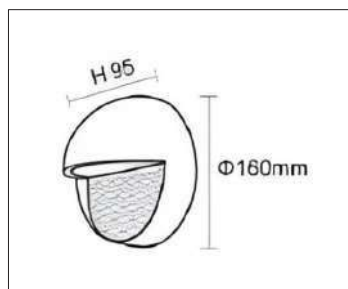

ELWL-1508

APPLICATIONS:

Outdoor Residential Building,
Parking Area, Industrial Spaces
& Petrol Station



Features

- Higher Lumen efficiency 100 lm/W
- Rated Life Time: 50,000 Hrs

Optional Features

- Dimming (DALI/1-10V)

PRODUCT PARAMETERS

PHYSICAL	
Housing	Die-Cast Aluminum
Diffuser	Frosted Glass
Finish	RAL 9007/RAL9005/RAL9016
Mounting	Wall Mount
OPTICAL	
Beam Angle	120°
UGR	--
ELECTRICAL	
CRI	≥90
CCT	3000K/4000K/6000K
Voltage / Frequency	220-240 VAC / 50-60Hz
Operating Temperature	-20°C to +50°C
Driver	In Built

PRODUCT DETAILS

Product Code	Wattage	Lumen	Product Size
ELWL 1508-A	12W	1200 lm	L148xW164xH105 mm
ELWL 1508-B	16W	1600 lm	L154xW220xH125 mm

PRODUCT DRAWING

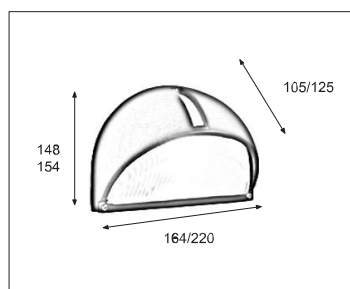

ELWL-1509



APPLICATIONS:

Outdoor Residential Building,
Commercial Spaces, Industrial
Spaces, Hospitality & Retail



Features

- Rated Life Time: 50,000 Hrs

Optional Features

- Dimming(DALI/1-10V)

PRODUCT PARAMETERS

PHYSICAL	
Housing	Die-Cast Aluminum
Diffuser	Clear Polycarbonate
Finish	White /Black
Mounting	Wall Mount
OPTICAL	
Beam Angle	24°/60°(20 & 30W only)
UGR	--
ELECTRICAL	
CRI	≥80
CCT	3000K/4000K/6000K
Voltage / Frequency	220-240 VAC / 50-60Hz
Operating Temperature	-20°C to +50°C
Driver	In Built

PRODUCT DETAILS

Product Code	Wattage	Lumen	Product Size
ELWL 1509-A	1x6W	540 lm	Ø90xH160 mm
ELWL 1509-B	2x6W	1080 lm	Ø90xH260 mm
ELWL 1509-C	1x8W	720 lm	Ø108xH200 mm
ELWL 1509-D	2x8W	1440 lm	Ø108xH300 mm
ELWL 1509-E	1x12W	1080 lm	Ø145xH200 mm
ELWL 1509-F	2x12W	2160 lm	Ø145xH300 mm
ELWL 1509-G	1x15W	1350 lm	Ø160xH200 mm
ELWL 1509-H	2x15W	2700 lm	Ø160xH300 mm
ELWL 1509-I	1X20W	1800 lm	Ø180xH200 mm
ELWL 1509-J	2x20W	3600 lm	Ø180xH300 mm
ELWL 1509-K	1x30W	2700 lm	Ø200xH250 mm
ELWL 1509-L	2x30W	5400 lm	Ø200xH350 mm

LED MIRROR LIGHT SERIES

LED Mirror Lights are designed not only to illuminate but also to enhance visual clarity and aesthetics in a variety of environments. Offering a blend of functional brightness and sleek design, these lights are ideal for both residential and commercial applications where precision lighting around mirrors is essential.



ELML-7010



ELML-7020



ELML-7030



ELML-7010



APPLICATIONS:
Bathrooms, Dressing Table
& Hotel Rooms

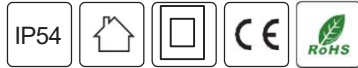

Features

- Higher Lumen efficiency 110 lm/W
- Rated Life Time: 50,000 Hrs.

Optional Features

- Dimming(DALI/0-10V/1-10V/Phase Dimming)

PRODUCT PARAMETERS

PHYSICAL	
Housing	Aluminum
Diffuser	Opal Polycarbonate
Finish	RAL 9016/1001/9006
Mounting	Wall Mount
OPTICAL	
Beam Angle	110°
UGR	--
ELECTRICAL	
CRI	≥80
CCT	3000K/4000K/6000K
Voltage / Frequency	220-240 VAC / 50-60Hz
Operating Temperature	-20°C to +50°C
Driver	In Built

PRODUCT DETAILS

Product Code	Wattage	Lumen	Product Size
ELML 7010-A	10W	1100 lm	A600xB81xC132xD61 mm
ELML 7010-B	15W	1650 lm	A900xB81xC132xD61 mm

PRODUCT DRAWING

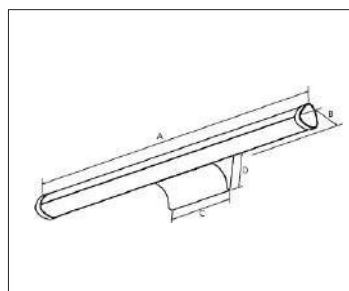

LIGHT DISTRIBUTION

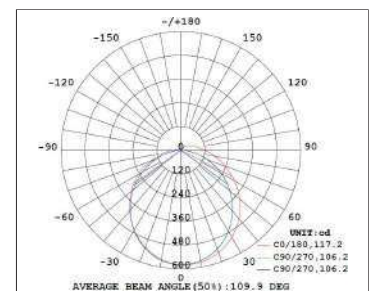

ELML-7020



APPLICATIONS:
Bathrooms, Dressing Table
& Hotel Rooms



Features

- Higher Lumen efficiency 110 lm/W
- Rated Life Time: 50,000 Hrs
- CCT Changeable
- Chrome Finish also Available
- Power Socket Available

Optional Features

- Dimming(DALI/0-10V/1-10V/Phase Dimming)

PRODUCT PARAMETERS

PHYSICAL	
Housing	Aluminium
Diffuser	Opal Polycarbonate
Finish	RAL 9016
Mounting	Wall Mount
OPTICAL	
Beam Angle	175x110°
UGR	--
ELECTRICAL	
CRI	≥80
CCT	3000K/4000K/5700K
Voltage / Frequency	220-240 VAC / 50-60Hz
Operating Temperature	-20°C to +50°C
Driver	In Built

PRODUCT DETAILS

Product Code	Wattage	Lumen	Product Size
ELML 7020-A	5W	600 lm	A450xB80xC80 mm
ELML 7020-B	8W	1000 lm	A555xB80xC80 mm
ELML 7020-C	10W	1150 lm	A555xB80xC80 mm

PRODUCT DRAWING

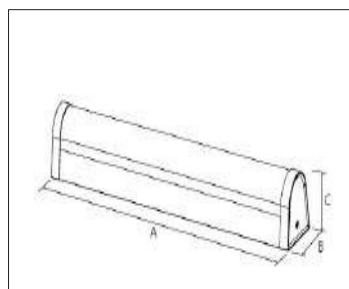

LIGHT DISTRIBUTION

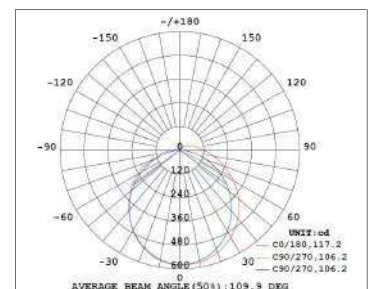

ELML-7030



APPLICATIONS:
Bathrooms, Dressing Table
& Hotel Rooms

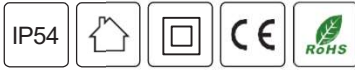

Features

- Higher Lumen efficiency 125 lm/W
- Rated Life Time: 50,000 Hrs
- CCT Changeable

Optional Features

- Dimming(DALI/0-10V/1-10V/Phase Dimming)

PRODUCT PARAMETERS

PHYSICAL	
Housing	Polycarbonate
Diffuser	Opal Polycarbonate
Finish	RAL 9016
Mounting	Wall Mount
OPTICAL	
Beam Angle	210x110°
UGR	--
ELECTRICAL	
CRI	≥80
CCT	3000K/4000K/5700K
Voltage / Frequency	220-240 VAC / 50-60Hz
Operating Temperature	-20°C to +50°C
Driver	In Built

PRODUCT DETAILS

Product Code	Wattage	Lumen	Product Size
ELML 7030-A	8W	1000 lm	A451xB50xC85 mm
ELML 7030-B	10W	1250 lm	A601xB50xC85 mm

PRODUCT DRAWING

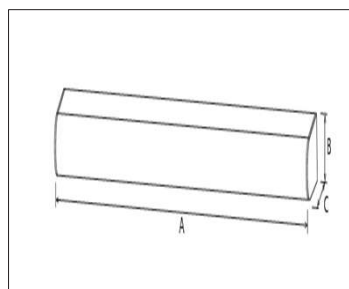

LIGHT DISTRIBUTION

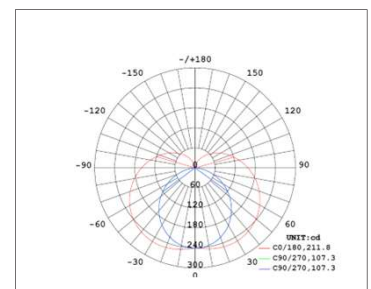





LINEAR LIGHT SERIES

Linear lights are lighting fixtures designed in a long, narrow form factor that provides consistent and uniform illumination across a linear axis. They are typically built using LED technology for energy efficiency, durability, and high performance. These fixtures can be mounted on ceilings, walls, or recessed into surfaces, and are available in various lengths, finishes, and color temperatures to suit different environments.



ELLR



ELLL/ELLS



ELLL-6001

ELLR / ELLS



APPLICATIONS:
Offices, Retail, Super Markets
& Shopping Mall

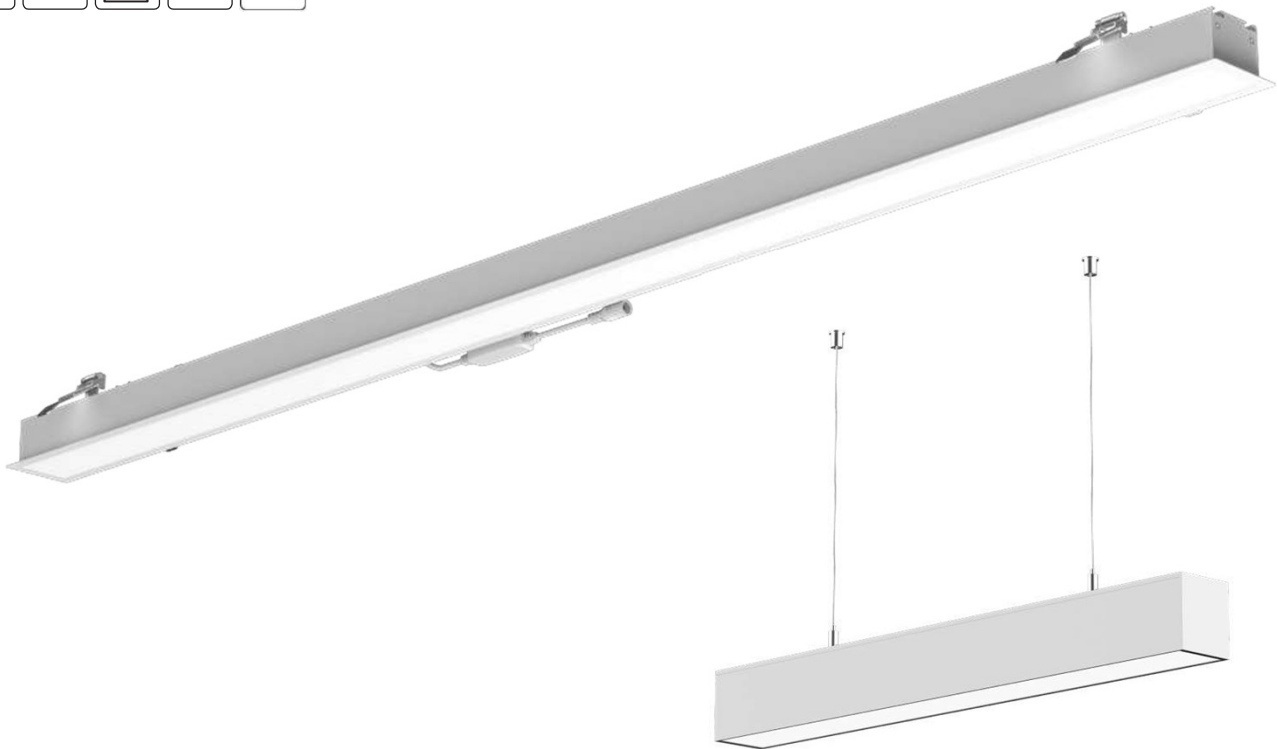

Features

- Rated Life Time: 50,000 Hrs
- IP40/44 Available upon Request
- Size Can be Customized as per the Requirement

Optional Features

- Dimming(DALI/0-10V/1-10V/Phase Dimming)
- Emergency Back up

PRODUCT PARAMETERS

PHYSICAL	
Housing	Painted Cold Rolled Steel
Diffuser	Polycarbonate
Finish	RAL 9003 /9006 /9010 /9016
Mounting	Recessed/Surface/ Suspended
OPTICAL	
Beam Angle	100°
UGR	--
ELECTRICAL	
CRI	≥80
CCT	3000K/4000K/6000K
Voltage / Frequency	220-240 VAC / 50-60Hz
Operating Temperature	-20°C to +50°C
Driver	Remote

PRODUCT DETAILS

Product Code	Wattage	Lumen	Product Size
ELLR / ELLS	20W	2000 lm	L1200xW70xH70 mm
	25W	2500 lm	L1200xW70xH70 mm
	30W	3000 lm	L1200xW70xH70 mm

PRODUCT DRAWING

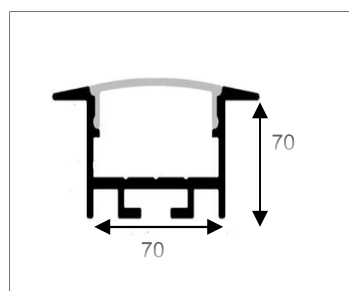

LIGHT DISTRIBUTION

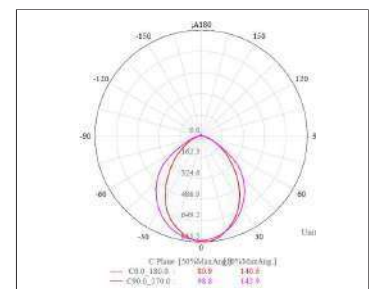

APPLICATIONS:

Offices, Retail, Super Markets
& Shopping Mall

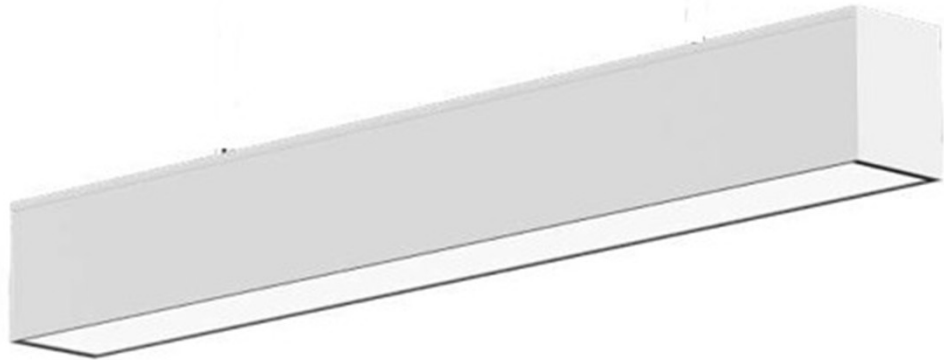
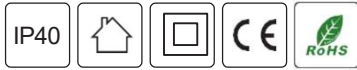

Features

- Higher Lumen efficiency 80-100 lm/W
- Rated Life Time: 50,000 Hrs
- IP44/IP 54 Available Upon Request
- Size Can be Customized as per the Requirement

Optional Features

- Dimming(DALI/0-10V/1-10V/Phase Dimming)
- Emergency Back up

PRODUCT PARAMETERS

PHYSICAL	
Housing	Extruded Aluminum
Diffuser	Opal Polycarbonate
Finish	RAL 9016 / RAL 9005
Mounting	Surface Mount / Suspended
OPTICAL	
Beam Angle	120°
UGR	--
ELECTRICAL	
CRI	≥80
CCT	3000K/4000K/6000K
Voltage / Frequency	220-240 VAC / 50-60Hz
Operating Temperature	-20°C to +50°C
Driver	Remote

PRODUCT DETAILS

Product Code	Wattage	Lumen	Product Size
ELLL	12W	1200 lm	L600xW50xH50mm
	16W	1600 lm	L600xW50xH50mm
	20W	2000 lm	L1200xW50xH50mm
	25W	2500 lm	L1200xW50xH50mm

PRODUCT DRAWING

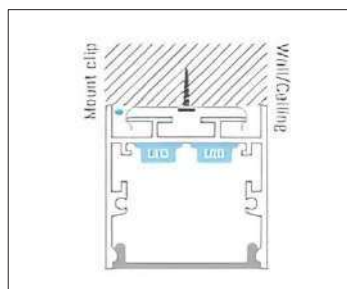

LIGHT DISTRIBUTION

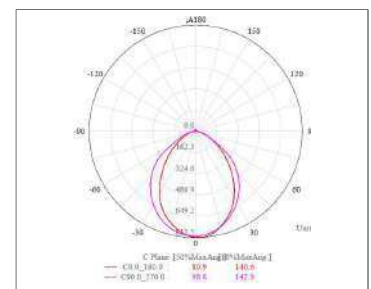

ELLL-6001



APPLICATIONS:
Offices, Retail, Super Markets
& Shopping Mall



Features

- Higher Lumen efficiency 120 lm/W
- Rated Life Time: 50,000 Hrs
- Size Can be Customized as per the Requirement

Optional Features

- Dimming(DALI/0-10V/1-10V/Phase Dimming)
- Emergency Back up

PRODUCT PARAMETERS

PHYSICAL	
Housing	Cold Rolled Steel
Diffuser	Opal Polycarbonate
Finish	RAL 9016
Mounting	Surface Mount/ Suspended
OPTICAL	
Beam Angle	100°
UGR	--
ELECTRICAL	
CRI	≥90
CCT	3000K/4000K/6000K
Voltage / Frequency	220-240 VAC / 50-60Hz
Operating Temperature	-20°C to +50°C
Driver	In Built

PRODUCT DETAILS

Product Code	Wattage	Lumen	Product Size
ELLL 6001	40W	4800 lm	L1220xW180xH90 mm

PRODUCT DRAWING

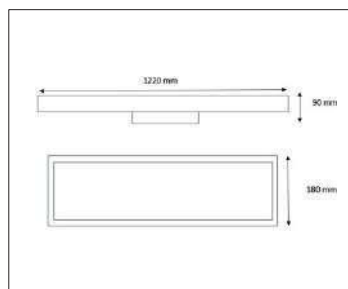

LIGHT DISTRIBUTION

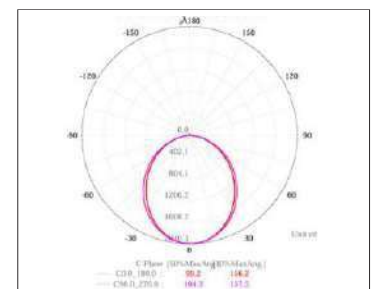



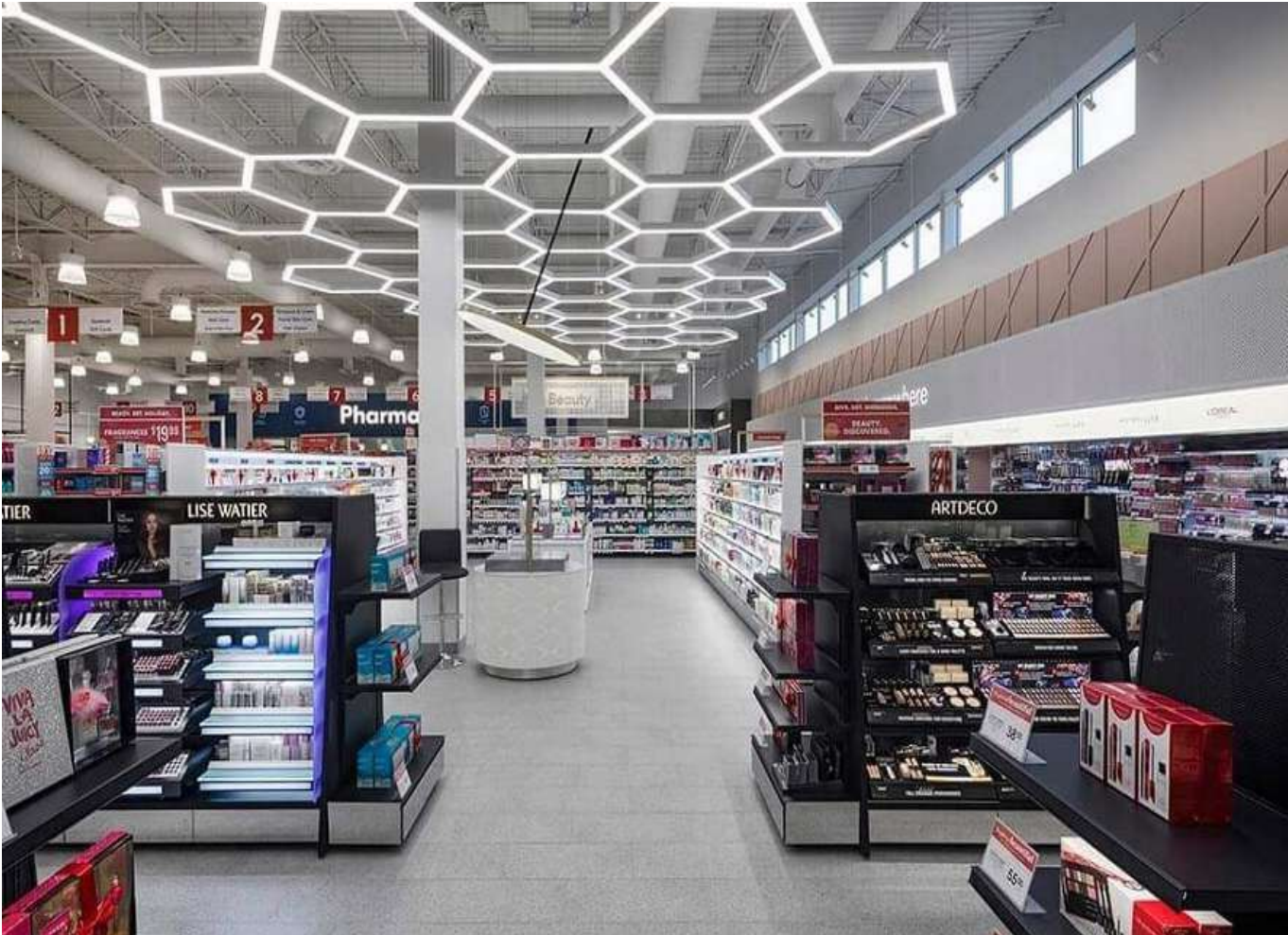

CUSTOMIZED LIGHTING PROFILE SERIES

Customized lighting profile is a tailored configuration of lighting settings designed to meet the specific needs, preferences, or functional requirements of a space or user. These profiles allow for personalized control over elements such as brightness, color temperature, hue, timing, and automation, enabling optimized lighting for activities like work, relaxation, entertainment, or display.



ELCP-6035



ELCP-6040



ELCP-6045



ELCP-6050



ELCP-6055

ELCP SERIES

APPLICATIONS:
Retail, Super Markets, Shopping
Mall, Exhibition Centers &
Showrooms

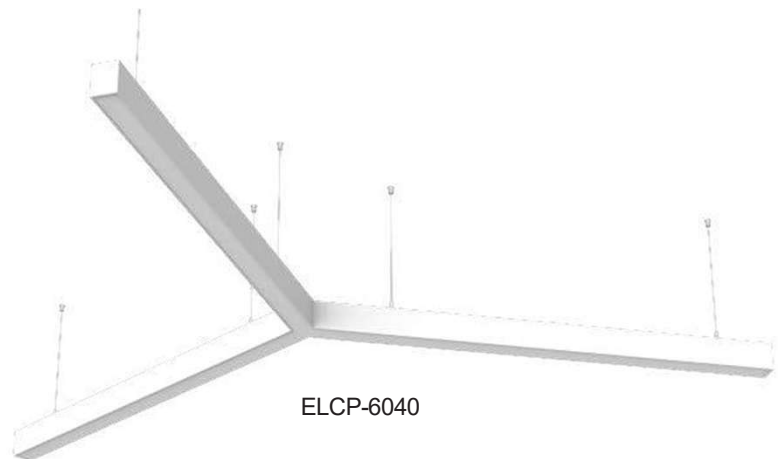

ELCP-6040

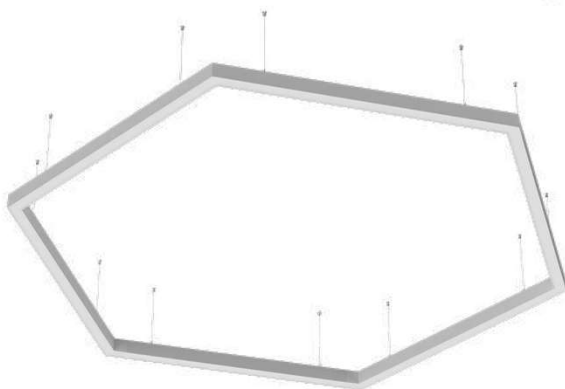

ELCP-6050

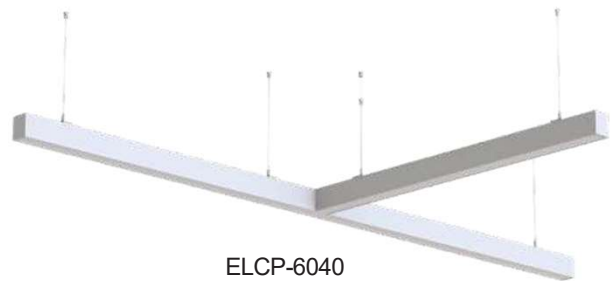

ELCP-6040

Features

- Higher Lumen efficiency
- Rated Life Time: 50,000 Hrs.
- Length can be Customized as per the requirement

Optional Features

- Dimming(DALI/0-10V/1-10V/Phase Dimming)

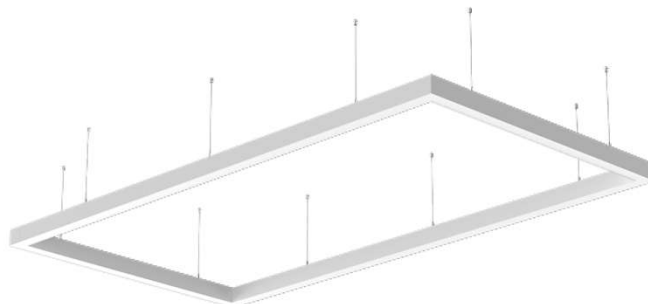

ELCP-6055

PRODUCT PARAMETERS

PHYSICAL	
Housing	Aluminum
Diffuser	Opal Polycarbonate
Finish	RAL 9016 / 9006
Mounting	Recessed / Suspended
OPTICAL	
Beam Angle	--
UGR	--
ELECTRICAL	
CRI	≥80
CCT	3000K/4000K/6000K
Voltage / Frequency	220-240 VAC / 50-60Hz
Operating Temperature	-20°C to +50°C
Driver	As per the Requirement



ELCP-6045





BATTEN / WRAPAROUND LIGHT SERIES

LED Batten Light /Wraparound Series is engineered for efficiency, durability, and ease of Mounting —making it the ideal linear lighting solution for residential, commercial, and industrial applications. With a sleek, low-profile design and powerful light output, these batten lights are a modern alternative to traditional fluorescent fixtures.



ESQ-BT



ESWAO



ESQ

ESQ-BT



APPLICATIONS:

Offices, Retail, Super Markets
Shopping Mall & Public Infrastructure



Features

- Higher Lumen efficiency 145 lm/W
- Rated Life Time: 50,000 Hrs.

Optional Features

- Dimming(DALI/0-10V/1-10V/Phase Dimming)

PRODUCT PARAMETERS

PHYSICAL	
Housing	Polycarbonate
Diffuser	Opal Polycarbonate
Finish	RAL 9016
Mounting	Surface Mount/ Suspended
OPTICAL	
Beam Angle	120°
UGR	--
ELECTRICAL	
CRI	≥80
CCT	3000K/4000K/6000K
Voltage / Frequency	220-240 VAC / 50-60Hz
Operating Temperature	-20°C to +50°C
Driver	In Built

PRODUCT DETAILS

Product Code	Wattage	Lumen	Product Size
ESQ-BT	20W	2900 lm	L600xW65xH66 mm
	40W	5800 lm	L1200xW65xH66 mm
	50W	7250 lm	L1500xW65xH66 mm
	60W	8700 lm	L1800xW65xH66 mm

PRODUCT DRAWING

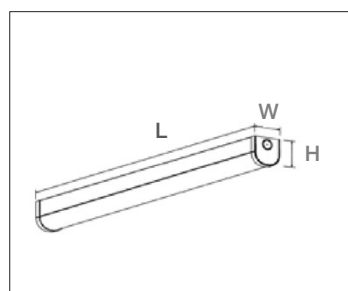

LIGHT DISTRIBUTION

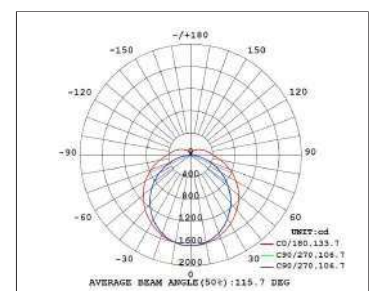

APPLICATIONS:

Offices, Retail, Super Markets
Shopping Mall & Public Infrastructure



Features

- Higher Lumen efficiency 140 lm/W
- Rated Life Time: 50,000 Hrs.

Optional Features

- Dimming(DALI/0-10V/1-10V/Phase Dimming)

PRODUCT PARAMETERS

PHYSICAL	
Housing	SPCC Cold Rolled Steel
Diffuser	Opal /Prismatic
Finish	RAL 9016
Mounting	Surface Mount/Suspended
OPTICAL	
Beam Angle	120°
UGR	--
ELECTRICAL	
CRI	≥80
CCT	3000K/4000K/6000K
Voltage / Frequency	220-240 VAC / 50-60Hz
Operating Temperature	-20°C to +50°C
Driver	In Built

PRODUCT DETAILS

Product Code	Wattage	Lumen	Product Size
ESWAO	10W	1400 lm	L600xW208xH77mm
	20W	2800 lm	L600xW208xH77mm
	30W	4200 lm	L1200xW208xH77mm
	40W	5600 lm	L1200xW208xH77mm
	60W	8400 lm	L1200xW208xH77mm

PRODUCT DRAWING

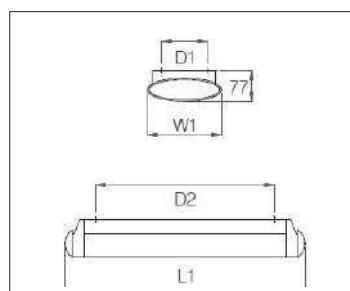

LIGHT DISTRIBUTION

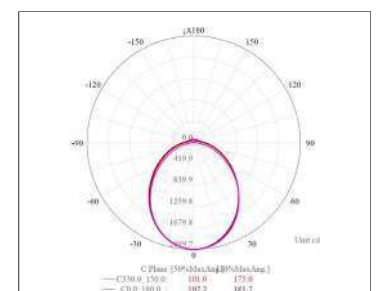

APPLICATIONS:

Offices, Retail, Super Markets
Shopping Mall & Public Infrastructure



Features

- Higher Lumen efficiency 140 lm/W
- Rated Life Time: 50,000 Hrs.

Optional Features

- Dimming(DALI/0-10V/1-10V/Phase Dimming)
- Microwave Sensor

PRODUCT PARAMETERS

PHYSICAL	
Housing	SPCC Cold Rolled Steel
Diffuser	Opal Polycarbonate
Finish	White
Mounting	Surface Mount / Suspended
OPTICAL	
Beam Angle	120°
UGR	--
ELECTRICAL	
CRI	≥80(≥90 upon Request)
CCT	3000K/4000K/6000K
Voltage / Frequency	220-240 VAC / 50-60Hz
Power Factor	>0.9
Operating Temperature	-20°C to +50°C
Driver	In Built
Sensor Distance	Height 3m(6m Max)

PRODUCT DETAILS

Product Code	Wattage	Lumen	Product Size
ESQ	9/12/15/18W	1260/1680/2100/2520 lm	L600xW64xH76 mm
	18/24/30/36W	2520/3360/4200/5040 lm	L1200xW64xH76 mm
	32/40/48/56W	4480/5600/6720/7840 lm	L1500xW64xH76 mm
	30/40/50/60W	4200/5600/7000/8400 lm	L1800xW64xH76 mm

PRODUCT DRAWING

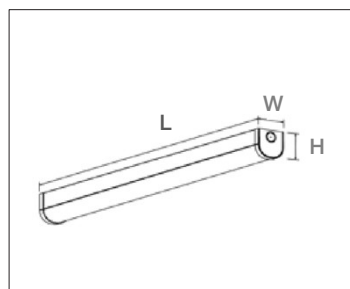

LIGHT DISTRIBUTION

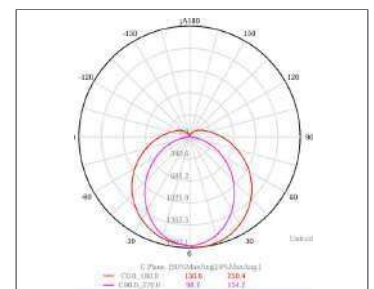





STREET LIGHT SERIES

High-Efficiency LED Street Light is designed for modern cityscapes, highways, parking lots, and industrial zones. Delivering outstanding brightness with low energy consumption, it offers a durable and cost-effective solution for outdoor lighting infrastructure.



ELFT 100-102



ELFT-103



ELFT-104



ELFT-105



ELFT-106

ELFT 100-101-102



APPLICATIONS:

Roads, Highways, Residential Societies, Industrial Zones, Parking Lots, Parks & Pathways



Features

- Higher Lumen efficiency 150 lm/W
- Rated Life Time: 50,000 Hrs.

Optional Features

- Dimming(DALI/1-10V)
- 70,000 Hrs. (Optional)

PRODUCT PARAMETERS

PHYSICAL	
Housing	Die Cast Aluminum
Diffuser	Tempered Glass
Finish	Light Grey/ Dark Grey/ Black
Mounting	Pole Mount
OPTICAL	
Beam Angle	Asymmetrical
UGR	--
ELECTRICAL	
CRI	≥70
CCT	3000K/4000K/6000K
Voltage / Frequency	220-240 VAC / 50-60Hz
Operating Temperature	-20°C to +50°C
Driver	In-Built

PRODUCT DETAILS

Product Code	Wattage	Lumen	Product Size
ELFT 10050	50W	7500 lm	L630xW229XH100 mm
ELFT 10080	80W	12,000 lm	L630xW229XH100 mm
ELFT 10160	160W	24,000 lm	L714xW259XH100 mm
ELFT 10200	200W	30,000 lm	L783xW317XH103 mm

PRODUCT DRAWING

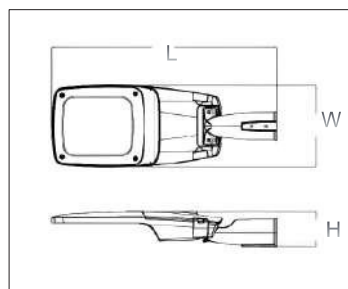

LIGHT DISTRIBUTION

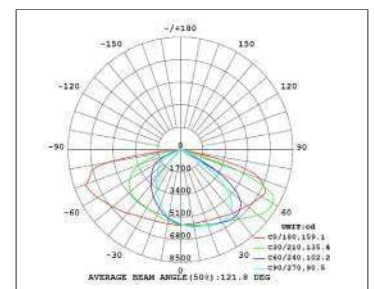

ELFT-103



APPLICATIONS:

Roads, Highways, Residential Societies, Industrial Zones, Parking Lots Parks & Pathways



Features

- Higher Lumen efficiency 140 lm/W
- Rated Life Time: 50,000 Hrs.

Optional Features

- Dimming(DALI/1-10V)
- 70,000 Hrs. (Optional)

PRODUCT PARAMETERS

PHYSICAL	
Housing	Die Cast Aluminum
Diffuser	Tempered Glass
Finish	Light Grey
Mounting	Pole Mount
OPTICAL	
Beam Angle	Asymmetrical
UGR	
ELECTRICAL	
CRI	≥70
CCT	3000K/4000K/6000K
Voltage / Frequency	220-240 VAC / 50-60Hz
Operating Temperature	-20°C to +50°C
Driver	In-Built

PRODUCT DETAILS

Product Code	Wattage	Lumen	Product Size
ELFT 103-A	30/40/50/60W	4200/5600/7000/8400 lm	L463xW173xH87mm
ELFT 103-B	70/80W	9800/11200 lm	L570xW200xH88mm
ELFT 103-C	90/100/110/120W	12600/14000/15400/16800 lm	L611xW240xH89mm
ELFT 103-D	140/160/180W	19600/22400/25200 lm	L680xW260xH111mm
ELFT 103-E	200/220/240W	28000/30800/33600 lm	L693xW300xH111mm

PRODUCT DRAWING

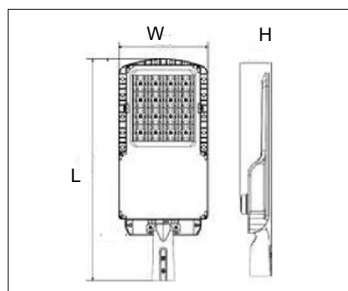

LIGHT DISTRIBUTION

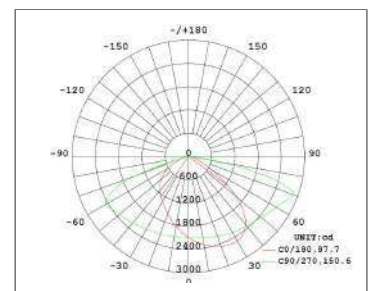

ELFT-104

APPLICATIONS:

Roads, Highways, Residential Societies, Industrial Zones, Parking Lots Parks & Pathways

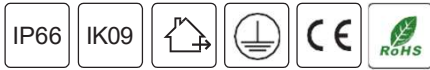

Features

- Higher Lumen efficiency 150 lm/W
- Rated Life Time: 50,000 Hrs.

Optional Features

- Dimming (DALI/1-10V)
- 70,000 Hrs. (Optional)

PRODUCT PARAMETERS

PHYSICAL	
Housing	Die Cast Aluminum
Diffuser	Tempered Glass
Finish	Light Grey
Mounting	Pole Mount
OPTICAL	
Beam Angle	Asymmetrical
UGR	--
ELECTRICAL	
CRI	≥70(≥80 upon Request)
CCT	3000K/4000K//6000K
Voltage / Frequency	220-240 VAC / 50-60Hz
Operating Temperature	-20°C to +50°C
Driver	In-Built

PRODUCT DETAILS

Product Code	Wattage	Lumen	Product Size
ELFT 104-A	60/80W	9000/12,000 lm	L606xW239xH117mm
ELFT 104-B	100/120/150W	15,000/18,000/22,500 lm	L682xW289xH118mm
ELFT 104-C	200/240W	30,000/36,000 lm	L733xW345xH119mm

PRODUCT DRAWING

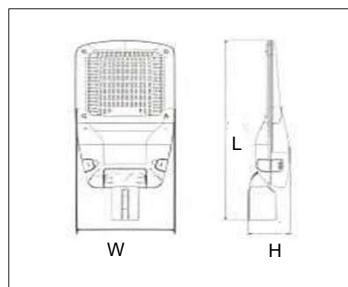

LIGHT DISTRIBUTION

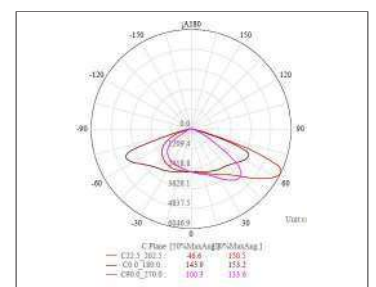

ELFT-105



APPLICATIONS:

Roads, Highways, Residential Societies, Industrial Zones, Parking Lots Parks & Pathways



Features

- Higher Lumen efficiency 140 lm/W
- Rated Life Time: 50,000 Hrs.

Optional Features

- Dimming (DALI/1-10V)
- 70,000 Hrs. (Optional)

PRODUCT PARAMETERS

PHYSICAL	
Housing	Die Cast Aluminum
Diffuser	Tempered Glass
Finish	Light Grey
Mounting	Pole Mount
OPTICAL	
Beam Angle	Asymmetrical
UGR	--
ELECTRICAL	
CRI	≥70(≥80 upon Request)
CCT	3000K/4000K/6000K
Voltage / Frequency	220-240 VAC / 50-60Hz
Operating Temperature	-20°C to +50°C
Driver	In Built

PRODUCT DETAILS

Product Code	Wattage	Lumen	Product Size
ELFT 105-A	40/60W	5600/8,400 lm	L514xW210xH111mm
ELFT 105-B	80/100W	11,200/14,000 lm	L578xW235xH95mm
ELFT 105-C	150/180W	21,000/25,200 lm	L770xW235xH95mm
ELFT 105-D	240W/300W	33,600/42000 lm	L895xW340xH107mm

PRODUCT DRAWING

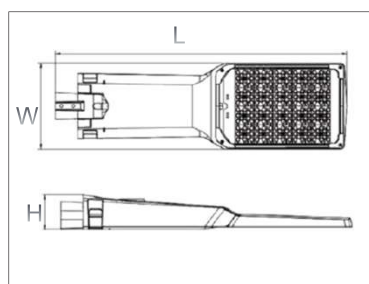

LIGHT DISTRIBUTION

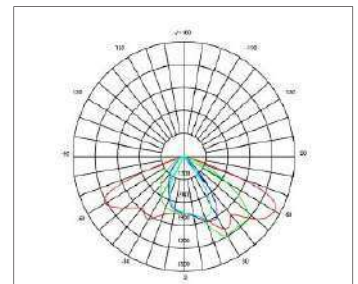

ELFT-106



APPLICATIONS:

Roads, Highways, Residential Societies, Industrial Zones, Parking Lots Parks & Pathways



Features

- Higher Lumen efficiency 155 lm/W
- Rated Life Time: 50,000 Hrs.

Optional Features

- Dimming (DALI/1-10V)
- 70,000 Hrs. (Optional)

PRODUCT PARAMETERS

PHYSICAL	
Housing	Die Cast Aluminum
Diffuser	Tempered Glass
Finish	Grey/Silver/Black
Mounting	Pole Mount
OPTICAL	
Beam Angle	Asymmetrical
UGR	-
ELECTRICAL	
CRI	≥70(≥80 upon Request)
CCT	3000K/4000K/6000K
Voltage / Frequency	220-240 VAC / 50-60Hz
Operating Temperature	-20°C to +50°C
Driver	In-Built

PRODUCT DETAILS

Product Code	Wattage	Lumen	Product Size
ELFT 106-A	40/60W/80/100W	6200/9300/12,400/15,500 lm	L545xW200xH97mm
ELFT 106-B	120/150/180	18,600/23,250/27,900 lm	L609xW235xH97mm
ELFT 106-C	240/270/300W	37,200/41,850/46,500 lm	L730xW300xH100mm

PRODUCT DRAWING

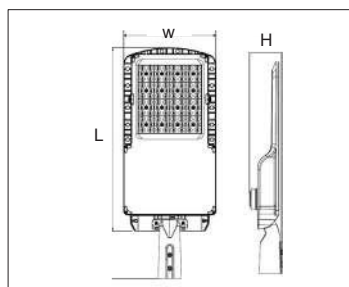

LIGHT DISTRIBUTION

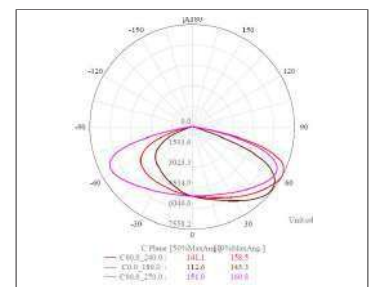





FLOOD LIGHT SERIES

LED Flood Light Series is engineered for powerful, wide-area illumination with maximum energy efficiency. Designed for both commercial and industrial applications, these flood lights offer a long-lasting, eco-friendly lighting solution for outdoor and large-space environments. Whether for stadiums, construction sites, parking lots, or facades, this series delivers robust performance under all conditions.



ELFD-807



ELFD-C



ELFD



ELHF-808

ELFD-807

APPLICATIONS:
Public Square, Airport, Railway,
Shipping Yard, Sporting Facility &
Container Loading Area

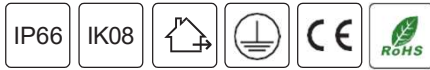

Features

- Higher Lumen efficiency 150 lm/W
- Rated Life Time: 50,000 Hrs

Optional Features

- Dimming (DALI/1-10V)
- 70,000 Hrs. (Optional)

PRODUCT PARAMETERS

PHYSICAL	
Housing	Die cast Aluminum
Diffuser	Tempered Glass
Finish	Black
Mounting	Wall /Pole Mount
OPTICAL	
Beam Angle	30°/60°/90°/120°/Asymmetrical
UGR	----
ELECTRICAL	
CRI	≥70
CCT	3000K/4000K/6000K
Voltage / Frequency	220-240 VAC / 50-60Hz
Operating Temperature	-20°C to +50°C
Driver	In Built

PRODUCT DETAILS

Product Code	Wattage	Lumen	Product Size
ELFD 807-A	50W	7500 lm	L259xW225xH49 mm
ELFD 807-B	80W	12000 lm	L306xW270xH55 mm
ELFD 807-C	100W	15000 lm	L306xW270xH55 mm
ELFD 807-D	150W	22500 lm	L359xW323xH63 mm
ELFD 807-E	200W	30000 lm	L403xW352WH63 mm
ELFD 807-F	250W	37500 lm	L466xW411xH65 mm
ELFD 807-G	300W	45000 lm	L466xW411xH65 mm
ELFD 807-H	400W	60000 lm	L475xW511xH70 mm
ELFD 807-I	500W	75000 lm	L628xW534xH73 mm
ELFD 807-J	600W	90000 lm	L628xW534xH73 mm

PRODUCT DRAWING

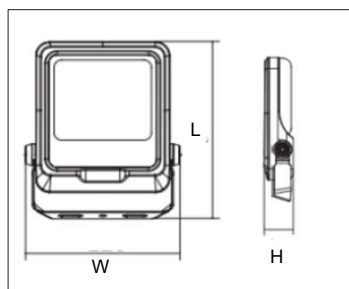

LIGHT DISTRIBUTION

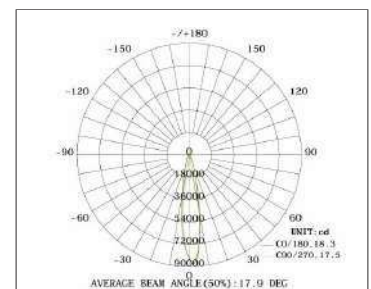

ELFD-C



APPLICATIONS:

Sporting Facility, Stadium, High Mast
Road Way, Industrial Areas, Railway
Port & Public Square

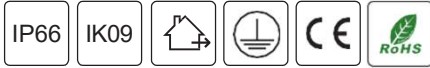

Features

- Higher Lumen efficiency 160 lm/W
- Rated Life Time: 50,000 Hrs.

Optional Features

- Dimming (DALI/1-10V)
- 70,000 Hrs. (Optional)

PRODUCT PARAMETERS

PHYSICAL	
Housing	Die Cast Aluminum
Diffuser	Polycarbonate
Finish	Black
Mounting	Pole Mount
OPTICAL	
Beam Angle	15°/20°/30°/45°/60°
UGR	--
ELECTRICAL	
CRI	≥70(≥80 upon Request)
CCT	3000K/4000K/6000K
Voltage / Frequency	220-240 VAC / 50-60Hz
Operating Temperature	-20°C to +50°C
Driver	In Built

PRODUCT DETAILS

Product Code	Wattage	Lumen	Product Size
ELFD -C	300W	48000 lm	L376xW416xH240 mm
	400W	64000 lm	L376xW416xH240 mm
	500W	80000 lm	L376xW416xH240 mm
	600W	96000 lm	L395xW416xH258 mm
	720W	115200 lm	L503.5xW552.5xH304 mm
	800W	128000 lm	L503.5xW552.5xH304 mm
	1000W	160000 lm	L503.5xW552.5xH304 mm

PRODUCT DRAWING

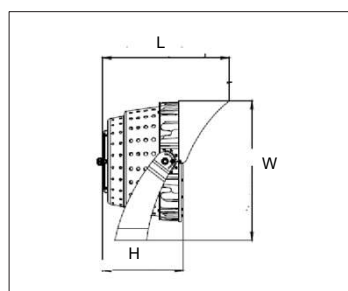

LIGHT DISTRIBUTION

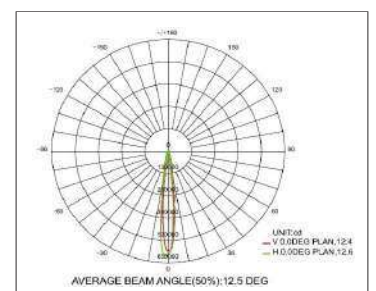

APPLICATIONS:
 Sporting Facility, Stadium, High Mast
 Road Way, Industrial Areas, Railway
 Port & Public Square



Features

- Higher Lumen efficiency 155 lm/W
- Rated Life Time: 50,000 Hrs.

Optional Features

- Dimming (DALI/1-10V)
- 70,000 Hrs. (Optional)

PRODUCT PARAMETERS

PHYSICAL	
Housing	Die Cast Aluminum
Diffuser	Polycarbonate
Finish	Black
Mounting	Wall /Pole Mount
OPTICAL	
Beam Angle	30°/60°
UGR	--
ELECTRICAL	
CRI	≥70(≥80 upon Request)
CCT	3000K/4000K/6000K
Voltage / Frequency	220-240 VAC / 50-60Hz
Operating Temperature	-20°C to +50°C
Driver	In Built

PRODUCT DETAILS

Product Code	Wattage	Lumen	Product Size
ELFD	200W	31000 lm	L425xW250xH137mm
	250W	38750 lm	L425xW250xH137mm
	300W	46500 lm	L425xW250xH137mm
	500W	77500 lm	L425xW600xH137mm
	600W	93000 lm	L425xW600xH137mm
	750W	116250 lm	L425xW950xH137mm
	1000W	155000 lm	L425xW950xH137mm

PRODUCT DRAWING

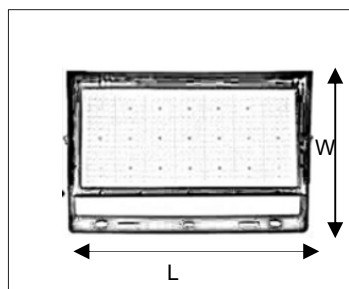

LIGHT DISTRIBUTION

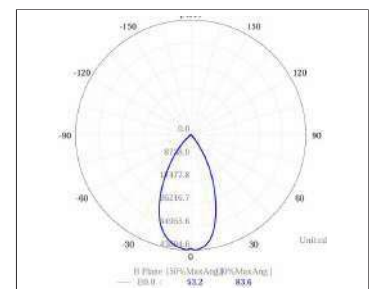

ELHF-808

APPLICATIONS:

Public Square, Airport, Railway,
Shipping Yard, Sporting Facility,
and Container Loading Area



Features

- Higher Lumen efficiency 150-160 lm/W
- Rated Life Time: 50,000 Hrs.

Optional Features

- Dimming (DALI/1-10V)
- 70,000 Hrs. (Optional)

PRODUCT PARAMETERS

PHYSICAL	
Housing	Die Cast Aluminum
Diffuser	Tempered Glass
Finish	Dark Grey
Mounting	Wall / Pole Mount
OPTICAL	
Beam Angle	Wide/Narrow/Asymmetrical
UGR	--
ELECTRICAL	
CRI	≥70
CCT	3000K/4000K/6000K
Voltage / Frequency	220-240 VAC / 50-60Hz
Operating Temperature	-20°C to +50°C
Driver	In-Built

PRODUCT DETAILS

Product Code	Wattage	Lumen	Product Size
ELHF 80050	50W	7800 lm	L300xW330XH85mm
ELHF 80075	75W	11500 lm	L300xW330XH85mm
ELHF 80100	100W	15000 lm	L300xW330XH85mm
ELHF 80150	150W	22000 lm	L440xW415XH85mm
ELHF 80160	160W	23000 lm	L440xW415XH85mm
ELHF 80180	180W	27000 lm	L440xW415XH85mm
ELHF 80200	200W	30000 lm	L440xW415XH85mm

PRODUCT DRAWING

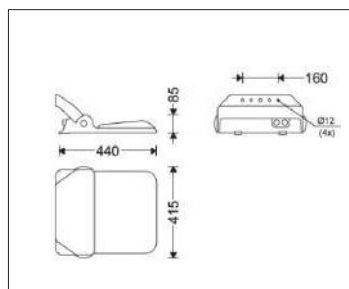

LIGHT DISTRIBUTION

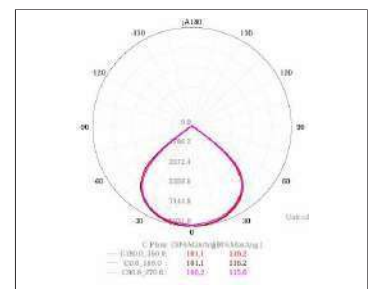



WALL WASHER LIGHT SERIES

Transform ordinary walls into dynamic visual statements with our Wall Washer Light Series. Designed for high performance architectural lighting, these luminaires evenly illuminate building facades, columns, and vertical surfaces adding depth, contrast, and drama to both contemporary and heritage architecture.

With precision optics, robust outdoor durability, and advanced LED control options including RGBW and DMX, the Wall Washer Series empowers designers to craft powerful lighting scenes that elevate the identity of any structure.



ELWW-1300



ELWW-1301

ELWW-1300



APPLICATIONS:
Exterior Walls, Square Night,
Garden Lighting, Interior Decoration
and Bridge Lighting

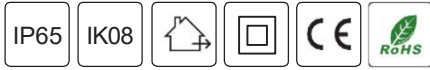

Features

- Rated Life Time: 50,000 Hrs

Optional Features

- Dimming (DALI/1-10V)

PRODUCT PARAMETERS

PHYSICAL	
Housing	Aluminum
Diffuser	Toughened Glass
Finish	Aluminum Oxide
Mounting	Surface Mount
OPTICAL	
Beam Angle	8°/15°/30°/45°/60°/10°60°
UGR	--
ELECTRICAL	
CRI	≥80
CCT	3000K/4000K/6000K
Voltage / Frequency	24 VDC
Operating Temperature	-20°C to +60°C
Driver	Remote

PRODUCT DETAILS

Product Code	Wattage	Lumen	Product Size
ELWW 1300-A	18W	1440 lm	L1000xW40xH70 mm
ELWW 1300-B	24W	1920 lm	L1000xW40xH70 mm
ELWW 1300-C	36W	2880 lm	L1000xW40xH70 mm

PRODUCT DRAWING

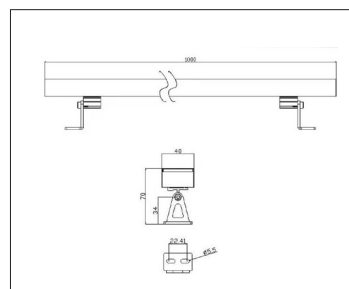

LIGHT DISTRIBUTION

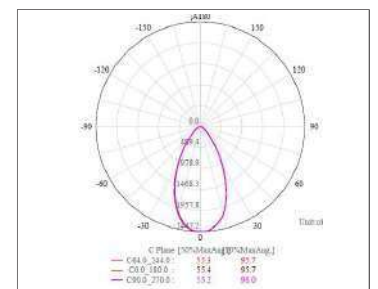



FACADE LIGHT SERIES

Facade Lighting Series is designed to transform building exteriors into stunning visual landmarks. Whether illuminating residential villas, commercial buildings, or public monuments, these fixtures highlight architectural features with precision, drama, and energy efficiency.

With a range of beam angles, color temperatures, and control options—including RGB and DMX—this series allows designers and engineers to craft dynamic lighting experiences that enhance a structure's character and visibility at night.



ELFL-1401



ELFL-1402

ELFL-1401



APPLICATIONS:

Architectural Highlighting, Corporate Offices, Restaurants, Resorts, Public & Cultural Buildings

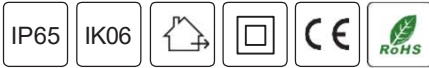

Features

- Rated Life Time: 50,000 Hrs

Optional Features

- 180° Adjustable Angle
- Dimming (DALI/1-10V)

PRODUCT PARAMETERS

PHYSICAL	
Housing	6063 Profile Aluminium
Diffuser	Tempered Glass Cover
Finish	--
Mounting	Recessed/Surface Mount
OPTICAL	
Beam Angle	120°
UGR	
ELECTRICAL	
CRI	≥80
CCT	3000K/4000K/6000K/RGBW
Voltage / Frequency	DC24V
Operating Temperature	-20°C to +50°C
Driver	Remote Driver

PRODUCT DETAILS

Product Code	Wattage	Lumen	Product Size
ELFL 1401-A	9W	720 lm	L1000xW40xH24
ELFL1402-B	12W	960 lm	L1000xW40xH24

PRODUCT DRAWING

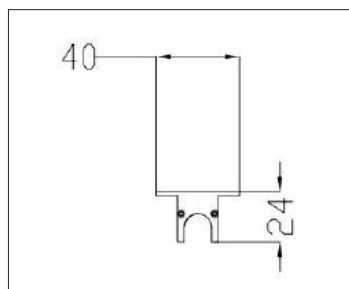

LIGHT DISTRIBUTION

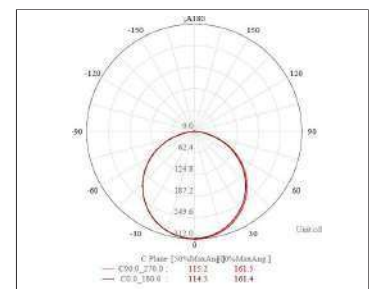

ELFL-1402



APPLICATIONS:

Architectural Highlighting, Corporate Offices, Restaurants, Resorts, Public & Cultural Buildings

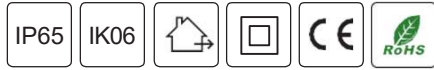

Features

- Rated Life Time: 50,000 Hrs

Optional Features

- 180° Adjustable Angle
- Dimming (DALI/1-10V)

PRODUCT PARAMETERS

PHYSICAL	
Housing	Extruded Aluminum
Diffuser	Tempered Glass Cover
Finish	--
Mounting	Surface Mount
OPTICAL	
Beam Angle	120°
UGR	
ELECTRICAL	
CRI	≥80
CCT	3000K/4000K/6000K/RGBW
Voltage / Frequency	DC24V
Operating Temperature	-20°C to +50°C
Driver	Remote Driver

PRODUCT DETAILS

Product Code	Wattage	Lumen	Product Size
ELFL 1402-A	12W	960 lm	L1000xW24.6xH50
ELFL 1402-B	15W	1200 lm	L1000xW24.6xH50

PRODUCT DRAWING

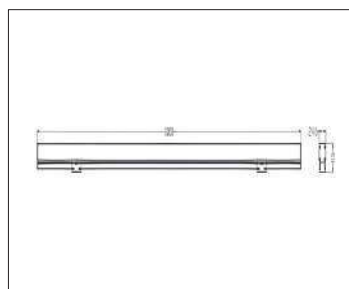

LIGHT DISTRIBUTION

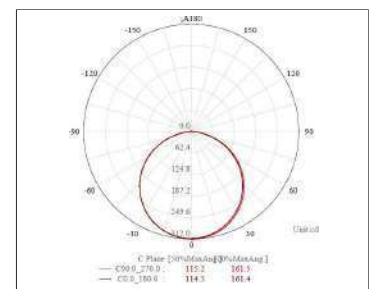



UP LIGHT SERIES

Up Light Series is designed to highlight architectural forms, landscaping features, and vertical surfaces with elegance and precision. Ideal for both indoor and outdoor applications, these fixtures project light upward to create dramatic accents, enhance textures, and increase night time visibility—while maintaining energy efficiency and durability.



ELUP-6710



ELUP-6720



ELUP-6730



ELUP-6740

ELUP-6710



APPLICATIONS:

Pathways, Gardens, Building
 Facades, Walkways, Driveways
 Signage & Monuments

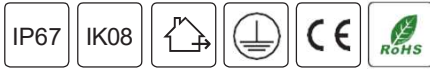

Features

- Rated Life Time: 50,000 Hrs

Optional Features

- Dimming (DALI/1-10V)

PRODUCT PARAMETERS

PHYSICAL	
Housing	Stainless steel top plate with Aluminum Housing
Diffuser	Toughened glass
Finish	Stainless steel
Mounting	Inground Recessed
OPTICAL	
Beam Angle	8°, 15°, 24°, 38°, 60°, 90°
UGR	--
ELECTRICAL	
CRI	≥90
CCT	3000K/4000K/6000K
Voltage / Frequency	220-240 VAC / 50-60Hz
Operating Temperature	-20°C to +50°C
Driver	In Built On/Off driver

PRODUCT DETAILS

Product Code	Wattage	Lumen	Cut Out	Product Size
ELUP 6710-A	3W	110 lm	Ø75	Ø80xH80 mm
ELUP 6710-B	6W	550 lm	Ø120	Ø130xH110 mm
ELUP 6710-C	9W	820 lm	Ø140	Ø150xH110 mm
ELUP 6710-D	12W	1100 lm	Ø170	Ø180xH115 mm
ELUP 6710-E	18W	1700 lm	Ø220	Ø230xH135 mm
ELUP 6710-F	24W	2200 lm	Ø250	Ø260xH155 mm
ELUP 6710-G	36W	3300 lm	Ø280	Ø300xH165 mm
ELUP 6710-H	50W	5500 lm	Ø330	Ø350xH180 mm

PRODUCT DRAWING

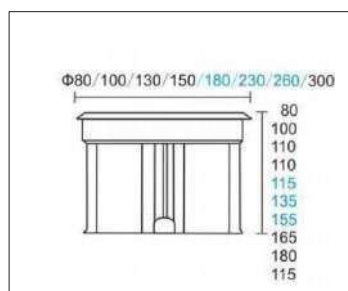

LIGHT DISTRIBUTION

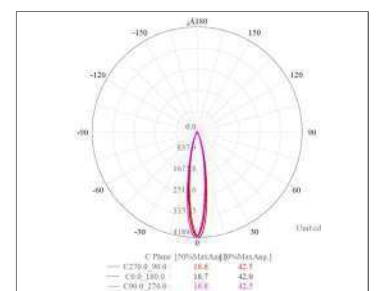

ELUP-6720



APPLICATIONS:

Pathways, Gardens, Building
 Facades, Walkways, Driveways
 Signage & Monuments

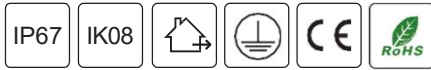

Features

- Rated Life Time: 50,000 Hrs

Optional Features

- Dimming (DALI/1-10V)

PRODUCT PARAMETERS

PHYSICAL	
Housing	Stainless steel top plate with Aluminum Housing
Diffuser	Toughened glass and honeycomb
Finish	Stainless steel
Mounting	Inground Recessed
OPTICAL	
Beam Angle	15°, 24°, 38°, 60°
UGR	--
ELECTRICAL	
CRI	≥90
CCT	3000K/4000K/6000K
Voltage / Frequency	220-240 VAC / 50-60Hz
Operating Temperature	-20°C to +50°C
Driver	In Built On/Off driver

PRODUCT DETAILS

Product Code	Wattage	Lumen	Cut Out	Product Size
ELUP 6720-A	7W	840 lm	Ø120	Ø130xH140 mm
ELUP 6720-B	9W	1080 lm	Ø120	Ø130xH140 mm
ELUP 6720-C	12W	1440 lm	Ø145	Ø160xH154 mm
ELUP 6720-D	15W	1800 lm	Ø165	Ø180xH165 mm

PRODUCT DRAWING

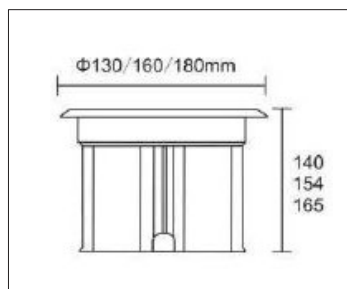

LIGHT DISTRIBUTION

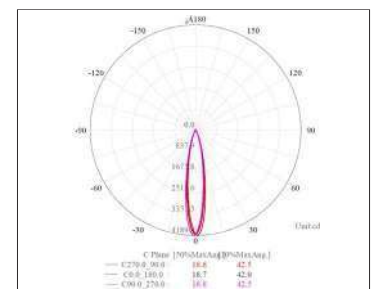

ELUP-6730



APPLICATIONS:

Pathways, Gardens, Building
 Facades, Walkways, Driveways
 Signage & Monuments

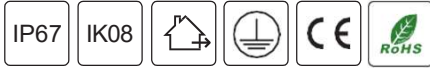

Features

- Rated Life Time: 50,000 Hrs

Optional Features

- Dimming (DALI/1-10V)

PRODUCT PARAMETERS

PHYSICAL	
Housing	Stainless steel top plate with Aluminum Housing
Diffuser	Toughened glass
Finish	Stainless steel
Mounting	Inground Recessed
OPTICAL	
Beam Angle	8°, 24°, 38°, 60°, 90°
UGR	--
ELECTRICAL	
CRI	≥90
CCT	3000K/4000K/6000K
Voltage / Frequency	220-240 VAC / 50-60Hz
Operating Temperature	-20°C to +50°C
Driver	In Built On/Off driver

PRODUCT DETAILS

Product Code	Wattage	Lumen	Cut Out	Product Size
ELUP 6730-A	4W	330 lm	120x120 mm	□85xH85mm
ELUP 6730-B	9W	990 lm	120x120 mm	□120xH115mm
ELUP 6730-C	12W	1320 lm	145x145 mm	□180xH120mm
ELUP 6730-D	16W	1760 lm	165x165 mm	□210xH130mm

PRODUCT DRAWING

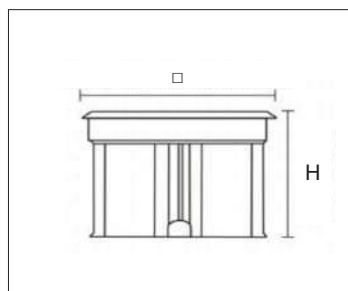

LIGHT DISTRIBUTION

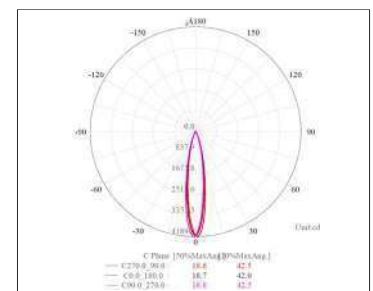

ELUP-6740



APPLICATIONS:

Pathways, Gardens, Building
 Facades, Walkways, Driveways
 Signage & Monuments

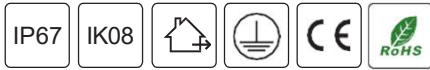

Features

- Rated Life Time: 50,000 Hrs.
- Adjustable Type

Optional Features

- Dimming (DALI/1-10V)

PRODUCT PARAMETERS

PHYSICAL	
Housing	Stainless steel top plate with Aluminum Housing
Diffuser	Toughened glass
Finish	Stainless steel
Mounting	Inground Recessed
OPTICAL	
Beam Angle	8°, 15°, 24°, 38°, 60°, 90°
UGR	--
ELECTRICAL	
CRI	≥90
CCT	3000K/4000K/6000K
Voltage / Frequency	220-240 VAC / 50-60Hz
Operating Temperature	-20°C to +50°C
Driver	In Built On/Off driver

PRODUCT DETAILS

Product Code	Wattage	Lumen	Cut Out	Product Size
ELUP 6740-A	6W	550 lm	Ø145	Ø150xH160 mm
ELUP 6740-B	12W	1100 lm	Ø175	Ø180xH165 mm
ELUP 6740-C	18W	1700 lm	Ø195	Ø210xH180 mm
ELUP 6740-D	24W	2200 lm	Ø245	Ø260xH225 mm
ELUP 6740-E	36W	3300 lm	Ø305	Ø320xH250 mm
ELUP 6740-F	60W	6600lm	Ø305	Ø320xH250 mm

PRODUCT DRAWING

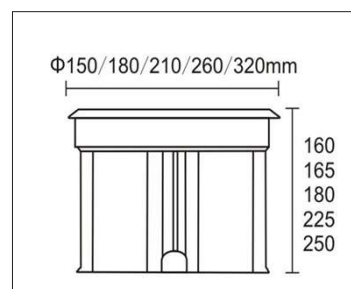

LIGHT DISTRIBUTION

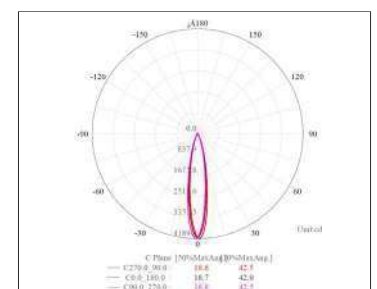



GROUND MARKER LIGHT SERIES

Ground Marker Light Series offers discreet, low-profile illumination for guiding pedestrians, enhancing safety, and accentuating architectural and landscape features. Built to blend seamlessly into pavements, pathways, driveways, and decks, these luminaires provide soft, directional light without disrupting the natural aesthetics of a space.

With durable materials, waterproof construction, and a range of beam angles and finishes, our ground marker lights are ideal for both functional and decorative outdoor lighting in residential, commercial and public environments.



ELGM-6400



ELGM-6410

ELGM-6400



APPLICATIONS:

Pathways, Gardens, Building
 Facades, Walkways, Driveways
 Signage & Monuments

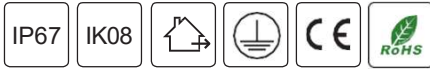

Features

- Rated Life Time: 50,000 Hrs

Optional Features

- Dimming (DALI/1-10V)

PRODUCT PARAMETERS

PHYSICAL	
Housing	Die cast Aluminium
Diffuser	Toughened glass 10mm thick
Finish	Graphite/Black
Mounting	Inground Recessed
OPTICAL	
Light Projection	One Way/Two Way/Three Way/Four Way
UGR	--
ELECTRICAL	
CRI	≥90
CCT	3000K/4000K/6000K
Voltage / Frequency	220-240 VAC / 50-60Hz
Operating Temperature	-20°C to +50°C
Driver	In Built On/Off driver

PRODUCT DETAILS

Product Code	Wattage	Lumen	Cut Out	Product Size
ELGM 6400-A	3W	330 lm	Ø95 mm	Ø100xH95 mm
ELGM 6400-B	6W	660 lm	Ø125 mm	Ø 130xH127 mm
ELGM 6400-C	9W	990 lm	Ø145 mm	Ø150xH142 mm
ELGM 6400-D	12W	1320 lm	Ø175 mm	Ø180xH150 mm

PRODUCT DRAWING

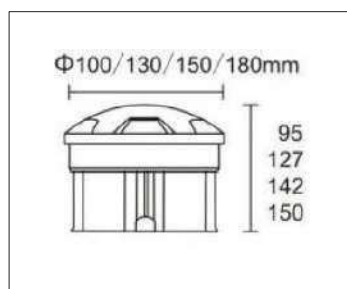

LIGHT DISTRIBUTION

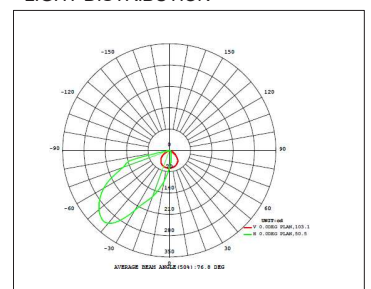

ELGM- 6410



APPLICATIONS:

Pathways, Gardens, Building
 Facades, Walkways, Driveways
 Signage & Monuments

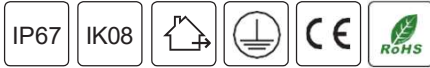

Features

- Rated Life Time: 50,000 Hrs

Optional Features

- Dimming (DALI/1-10V)

PRODUCT PARAMETERS

PHYSICAL	
Housing	Stainless steel top with Die Cast Aluminum
Diffuser	Tempered glass 10mm thick
Finish	Stainless Steel Finish
Mounting	Inground Recessed
OPTICAL	
Light Projection	One /Two /Four Way
UGR	--
ELECTRICAL	
CRI	≥90
CCT	3000K/4000K/6000K
Voltage / Frequency	220-240 VAC / 50-60Hz
Operating Temperature	-20°C to +50°C
Driver	In Built On/Off driver

PRODUCT DETAILS

Product Code	Wattage	Lumen	Cut Out	Product Size
ELGM 6410-A	6W	600 lm	Ø115 mm	120x120 mm

PRODUCT DRAWING

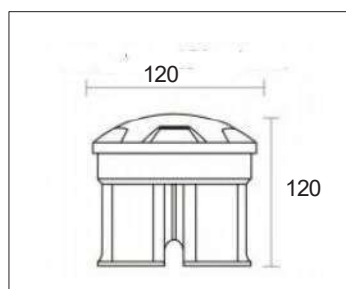

LIGHT DISTRIBUTION

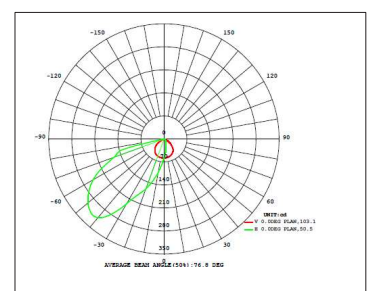



POLE TOP LIGHT SERIES

Pole Top Light is a modern, energy-efficient lighting solution designed for streets, parks, pathways, campuses, and commercial outdoor areas. With powerful LED technology, uniform light distribution, and durable construction, it ensures safety, visibility, and aesthetics—all in one fixture. Built to perform in demanding environments, it features a weatherproof housing, multiple wattage and CCT options, and is compatible with smart lighting controls for intelligent outdoor illumination.



ELPL-140



ELPL-141

ELPL-140



APPLICATIONS:

Roadway, Parks, Public Square,
Private Garden, Residential Area
Walkway & Pathway

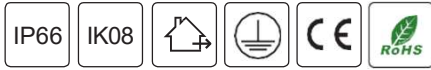

Features

- High Lumen Efficiency 150 lm/W
- Rated Life Time: 50,000 Hrs

Optional Features

- Dimming (DALI/1-10V)

PRODUCT PARAMETERS

PHYSICAL	
Housing	Die Cast Aluminum
Diffuser	Tempered Glass
Finish	Black
Mounting	Pole Top
OPTICAL	
Beam Angle	Symmetrical / Asymmetrical
UGR	--
ELECTRICAL	
CRI	≥70
CCT	3000K/4000K/5000K
Voltage / Frequency	220-240 Vac/50-60 Hz
Operating Temperature	-20°C to +50°C
Driver	In-Built Driver

PRODUCT DETAILS

Product Code	Wattage	Lumen	Product Size
ELPL 140-1A/2A	30W	4500 lm	Ø400xH531/Ø400xH509 mm
ELPL 140-1B/2B	50W	7500 lm	Ø400xH531/Ø400xH509 mm
ELPL 140-1C/2C	60W	9000 lm	Ø400xH531/Ø400xH509 mm
ELPL 140-1D/2D	75W	11250 lm	Ø400xH531/Ø400xH509 mm
ELPL 140-1E/2E	100W	15000 lm	Ø400xH542/Ø400xH523 mm
ELPL 140-1F/2F	120W	18000 lm	Ø400xH542/Ø400xH523 mm
ELPL 140-1G/2G	150W	22500 lm	Ø400xH542/Ø400xH523 mm

PRODUCT DRAWING

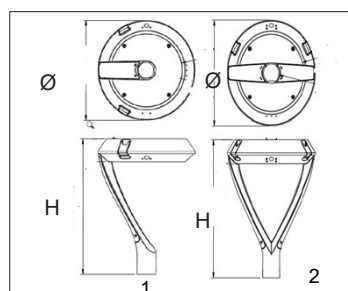

LIGHT DISTRIBUTION

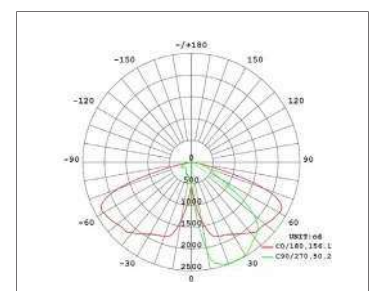

ELPL-141

APPLICATIONS:

Roadway, Parks, Public Square,
Private Garden, Residential Area
Walkway & Pathway

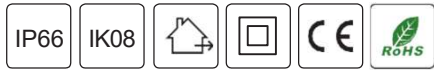

Features

- High Lumen Efficiency 120 lm/W
- Rated Life Time: 50,000 Hrs

Optional Features

- Dimming (DALI/1-10V)

PRODUCT PARAMETERS

PHYSICAL	
Housing	Die Cast Aluminum
Diffuser	Tempered Glass
Finish	Black
Mounting	Pole Top
OPTICAL	
Beam Angle	Symmetrical / Asymmetrical
ELECTRICAL	
CRI	≥70, ≥80(Optional)
CCT	3000K/4000K/5000K
Voltage / Frequency	220-240 Vac/50-60 Hz
Operating Temperature	-20°C to +50°C
Driver	In-Built Driver

PRODUCT DETAILS

Product Code	Wattage	Lumen	Product Size
ELPL 141-A	40W	4500 lm	L450xH526mm
ELPL 141-B	60W	7500 lm	L450xH526mm
ELPL 141-C	75W	9000 lm	L450xH526mm
ELPL 141-D	100W	11250 lm	L450xH526mm

PRODUCT DRAWING

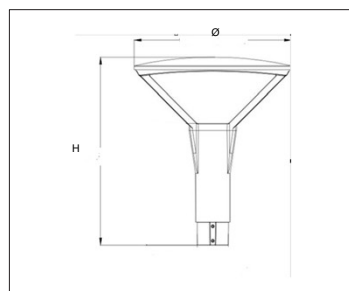

LIGHT DISTRIBUTION

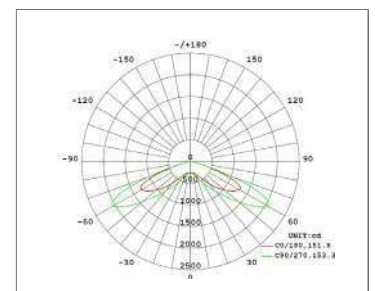

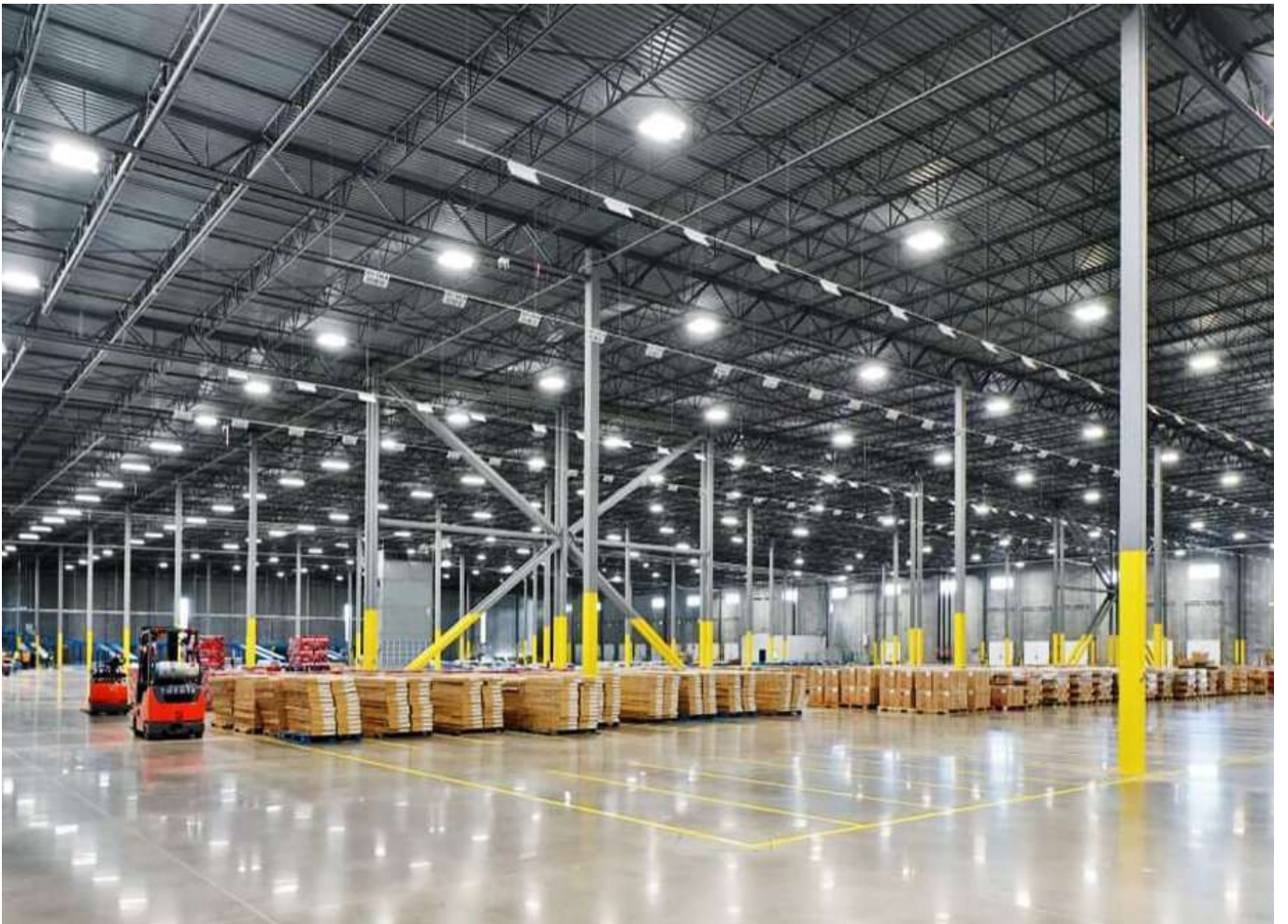

HIGH BAY LIGHT SERIES

High Bay Light Series is engineered to deliver exceptional brightness, durability, and energy efficiency for industrial and commercial environments with high ceilings. Ideal for warehouses, factories, large retail stores, and sports arenas, these fixtures provide uniform light distribution from elevated heights—ensuring safety, productivity, and cost savings.

With a range of wattages, beam angles, and control options, the series meets the demands of both new installations and energy-efficient retrofits.



ELHB-810



ELHB-811



ELHB-812



ELHB-813

ELHB-810



APPLICATIONS:
Warehouse, Super Market
& Retail



Features

- High Lumen Efficiency 170 lm/W
- Rated Life Time: 50,000 Hrs.

Optional Features

- Dimming (DALI/1-10V)
- Power and CCT Tunable
- 70,000 Hrs. (Optional)

PRODUCT PARAMETERS

PHYSICAL	
Housing	Die cast Aluminum
Diffuser	Polycarbonate Lens
Finish	Milky White
Mounting	Surface/Suspended
OPTICAL	
Beam Angle	60°/90°/120°
UGR	--
ELECTRICAL	
CRI	≥70(≥80 Optional)
CCT	3000K/4000K/5000K/6000K
Voltage / Frequency	220-240 VAC / 50-60Hz
Operating Temperature	-20°C to +50°C
Driver	In Built driver

PRODUCT DETAILS

Product Code	Wattage	Lumen	Product Size
ELHB 810-A	100W	17000 lm	L416xW381xH262
ELHB 810-B	150W	25500 lm	L416xW381xH262

PRODUCT DRAWING

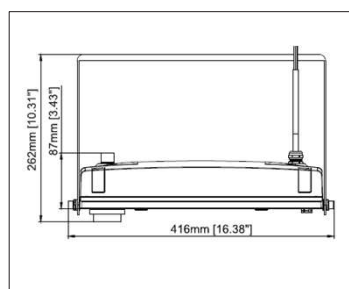

LIGHT DISTRIBUTION

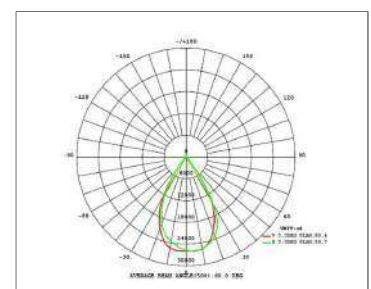

ELHB-811



APPLICATIONS:
Warehouse, Factory Industrial
Facility, Exhibition Centers,
& Stadiums

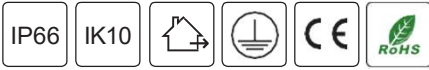

Features

- High Lumen Efficiency 160 lm/W
- Rated Life Time: 50,000 Hrs.

Optional Features

- Dimming (DALI/1-10V)
- PIR/Microwave Motion Sensor
- 70,000 Hrs. (Optional)

PRODUCT PARAMETERS

PHYSICAL	
Housing	Aluminum Alloy
Diffuser	Polycarbonate Lens
Finish	Silver Grey Finish
Mounting	Suspended Mount/Ceiling Mount
OPTICAL	
Beam Angle	60°/90°/120°
UGR	--
ELECTRICAL	
CRI	≥70(≥80 Optional)
CCT	3000K/4000K/5000K
Voltage / Frequency	220-240 VAC / 50-60Hz
Operating Temperature	-20°C to +50°C
Driver	In Built driver

PRODUCT DETAILS

Product Code	Wattage	Lumen	Product Size
ELHB 811-A	100W	16000 lm	L340xW325xH60 mm
ELHB 811-B	150W	24000 lm	L340xW325xH60 mm
ELHB 811-C	200W	32000 lm	L680xW325xH60 mm
ELHB 811-D	240W	38400 lm	L680xW325xH60 mm
ELHB 811-E	300W	48000 lm	L680xW325xH60 mm
ELHB 811-F	400W	64000 lm	L1020xW325xH60 mm
ELHB 811-G	480W	74400 lm	L1020xW325xH60 mm

PRODUCT DRAWING

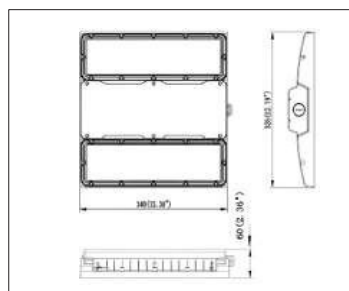

LIGHT DISTRIBUTION

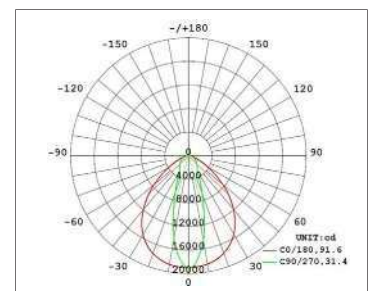

ELHB-812

APPLICATIONS:

Warehouse, Exhibition Hall,
Garage, Factory, Logistics
Center & Indoor Stadium

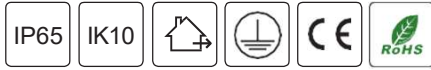

Features

- High Lumen Efficiency 170 lm/W
- Rated Life Time: 50,000 Hrs.
- Power Adjustable

Optional Features

- Dimming(DALI/1-10V)
- 70,000 Hrs. (Optional)

PRODUCT PARAMETERS

PHYSICAL	
Housing	Die cast Aluminum
Diffuser	Polycarbonate Lens
Finish	Black
Mounting	Suspended Mount/Ceiling Mount
OPTICAL	
Beam Angle	60°/90°/120°
UGR	--
ELECTRICAL	
CRI	≥70(≥80 Optional)
CCT	3000K/4000K/5000K
Voltage / Frequency	220-240 VAC / 50-60Hz
Operating Temperature	-20°C to +50°C
Driver	In Built driver

PRODUCT DETAILS

Product Code	Wattage	Lumen	Product Size
ELHB 812-A	150/100/80W	25,500/17,000/13,600 lm	Ø308xH155 mm
ELHB 812-B	300/240/200W	51,000/40,800/34,000 lm	Ø404xH168 mm

PRODUCT DRAWING

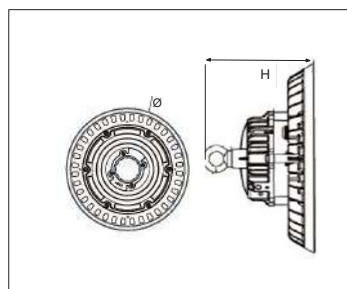

LIGHT DISTRIBUTION

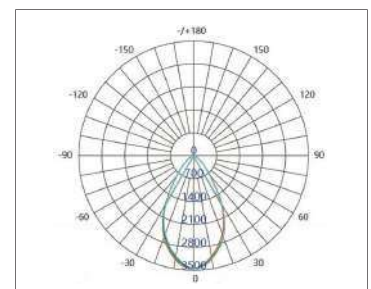

ELHB-813



APPLICATIONS:
Warehouse, Factory, Industrial
Facility, Exhibition Centers,
Stadiums & Toll Stations



Features

- High Lumen Efficiency 160 lm/W
- Rated Life Time: 50,000 Hrs.

Optional Features

- Dimming(DALI/1-10V)
- 70,000 Hrs. (Optional)

PRODUCT PARAMETERS

PHYSICAL	
Housing	Die cast Aluminum
Diffuser	Polycarbonate Lens
Finish	Black
Mounting	Suspended Mount/Bracket Mount
OPTICAL	
Beam Angle	30°/60°/90°/120°
UGR	--
ELECTRICAL	
CRI	≥70(≥80 Optional)
CCT	3000K/4000K/5000K
Voltage / Frequency	220-240 VAC / 50-60Hz
Operating Temperature	-20°C to +50°C
Driver	In-Built driver

PRODUCT DETAILS

Product Code	Wattage	Lumen	Product Size
ELHB 813-A	100W	16000 lm	□262xH165 mm
ELHB 813-B	150W	24000 lm	□314xH165 mm
ELHB 813-C	200W	32000 lm	□314xH165 mm

PRODUCT DRAWING



LIGHT DISTRIBUTION

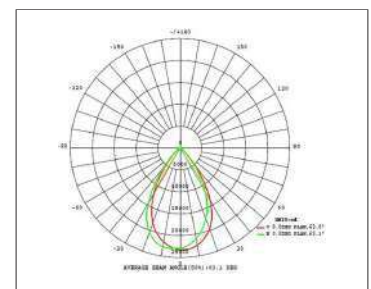



GARDEN LIGHT SERIES

Garden Light Series is a perfect blend of aesthetics and performance—crafted to enhance the beauty of outdoor spaces while providing safe, reliable illumination. Designed with both form and function in mind, these luminaires highlight pathways, plants, architectural details, and gathering areas with soft, focused lighting that brings outdoor environments to life after sunset.



ELGL-3510



ELGL-3520



ELGL-3530



ELGL-3540



ELGL-3550

ELGL-3510



APPLICATIONS:

Pathways, Gardens Building
 Facades, Walkways, Driveways
 Signage & Monuments



Features

- Rated Life Time: 50,000 Hrs

Optional Features

- Dimming(DALI/1-10V)
- Multiple Mounting Methods

PRODUCT PARAMETERS

PHYSICAL	
Housing	Die-cast Aluminium housing
Diffuser	Toughened glass
Finish	RAL 9005 /9007
Mounting	Surface/Pole/Spike
OPTICAL	
Beam Angle	14°, 24°, 45°, 60°
UGR	--
ELECTRICAL	
CRI	≥90
CCT	3000K/4000K/6000K/Red/Green/Blue
Voltage / Frequency	220-240 VAC / 50-60Hz
Operating Temperature	-20°C to +50°C
Driver	In-Built driver

PRODUCT DETAILS

Product Code	Wattage	Lumen	Product Size
ELGL 3510.1A	20W	2200 lm	Ø132xH230 mm
ELGL 3510.1B	30W	3300 lm	Ø160xH260 mm
ELGL 3510.2A	20W	2200 lm	Ø132xH230 mm
ELGL 3510.2B	30W	3300 lm	Ø132xH260 mm
ELGL 3510.3A	20W	2200 lm	Ø132xH460 mm
ELGL 3510.3B	30W	3300 lm	Ø160xH490 mm
ELGL 3510.4A	20W	2200 lm	Ø132xH342 mm
ELGL 3510.4B	30W	3300 lm	Ø160xH370 mm

PRODUCT DRAWING

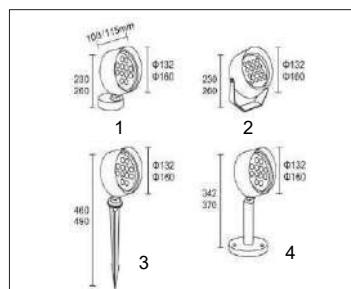

LIGHT DISTRIBUTION

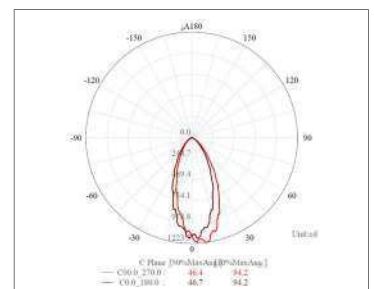

ELGL-3520



APPLICATIONS:

Pathways, Gardens Building
 Facades, Walkways, Driveways
 Signage & Monuments

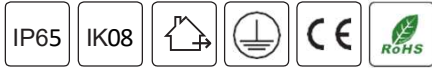

Features

- Rated Life Time: 50,000 Hrs

Optional Features

- Dimming(DALI/1-10V)
- Multiple Mounting Methods

PRODUCT PARAMETERS

PHYSICAL	
Housing	Die-cast Aluminium housing
Diffuser	Toughened glass
Finish	RAL 9005 /9007
Mounting	Surface /Spike/Pole
OPTICAL	
Beam Angle	14°, 24°, 45°, 60°
UGR	--
ELECTRICAL	
CRI	≥90
CCT	3000K/4000K/6000K/Red/Green/Blue
Voltage / Frequency	220-240 VAC / 50-60Hz
Operating Temperature	-20°C to +50°C
Driver	In-Built driver

PRODUCT DETAILS

Product Code	Wattage	Lumen	Product Size
ELGL 3520-1A	12W	1320 lm	□105xH140 mm
ELGL 3520-1B	20W	2200 lm	□150xH175 mm
ELGL 3520-1C	34W	3300 lm	□200xH260 mm
ELGL 3520-1D	50W	5500 lm	□235xH305 mm
ELGL 3520-1E	70W	7700 lm	□235xH305 mm
ELGL 3520-2A	12W	1320 lm	□105xH140 mm
ELGL 3520-2B	20W	2200 lm	□150xH175 mm
ELGL 3520-2C	34W	3300 lm	□200xH260 mm
ELGL 3520-2D	50W	5500 lm	□235xH305 mm
ELGL 3520-2E	70W	7700 lm	□235xH305 mm
ELGL 3520-3A	12W	1320 lm	□105xH380 mm
ELGL 3520-3B	20W	2200 lm	□150xH445 mm
ELGL 3520-4A	12W	1320 lm	□105xH380 mm
ELGL 3520-4B	20W	2200 lm	□150xH445 mm

PRODUCT DRAWING

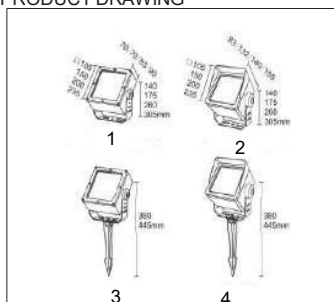

LIGHT DISTRIBUTION

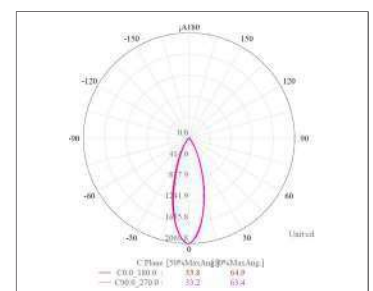

ELGL-3530



APPLICATIONS:

Pathways, Gardens Building
 Facades, Walkways, Driveways
 Signage & Monuments

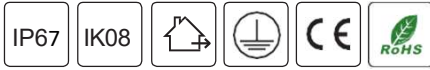

Features

- Rated Life Time: 50,000 Hrs

Optional Features

- Dimming(DALI/1-10V)

PRODUCT PARAMETERS

PHYSICAL	
Housing	Die-cast Aluminium housing
Diffuser	Toughened glass
Finish	RAL 9005 /9007
Mounting	Surface/Pole/Spike
OPTICAL	
Beam Angle	8°, 24°, 38°, 60°
UGR	--
ELECTRICAL	
CRI	≥90
CCT	3000K/4000K/6000K/Red/Green/Blue
Voltage / Frequency	220-240 VAC / 50-60Hz
Operating Temperature	-20°C to +50°C
Driver	In-Built driver

PRODUCT DETAILS

Product Code	Wattage	Lumen	Product Size
ELGL 3530-A	24W	2640 lm	Ø220xW250xH300
ELGL 3530-B	36W	2640lm	Ø220xW250xH300
ELGL 3530-C	36W	3960 lm	Ø265xW310xH350
ELGL 3530-D	54W	5940 lm	Ø265xW310xH350

PRODUCT DRAWING

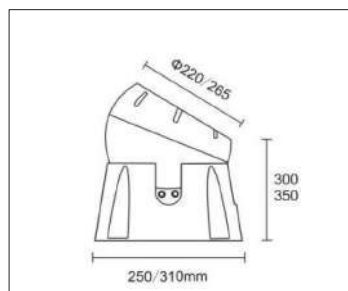

LIGHT DISTRIBUTION

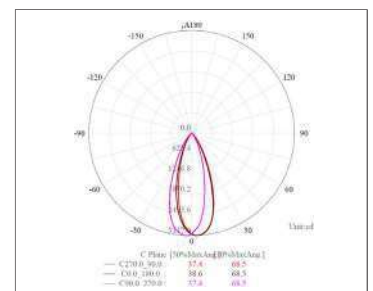

ELGL-3540



APPLICATIONS:

Pathways, Gardens Building
 Facades, Walkways, Driveways
 Signage & Monuments



Features

- Rated Life Time: 50,000 Hrs

Optional Features

- Dimming(DALI/1-10V)

PRODUCT PARAMETERS

PHYSICAL	
Housing	Diecast Aluminum
Diffuser	Polycarbonates & Toughened glass
Finish	RAL 9005 /9007
Mounting	Surface / Spike Mount
OPTICAL	
Beam Angle	8°, 24°, 38°, 60°
UGR	--
ELECTRICAL	
CRI	≥90
CCT	3000K/4000K/6000K
Voltage / Frequency	220-240 VAC / 50-60Hz
Operating Temperature	-20°C to +50°C
Driver	In-Built driver

PRODUCT DETAILS

Product Code	Wattage	Lumen	Product Size
ELGL 3540 1A/2A	9W	1080 lm	Ø85xH230/Ø85XH400
ELGL 3540 1B/2B	18W	1980 lm	Ø125xH270/Ø125XH450
ELGL 3540 1C/2C	24W	2880 lm	Ø165xH310/Ø165XH515
ELGL 3540 1D/2D	36W	4320 lm	Ø165xH310/Ø165XH515

PRODUCT DRAWING

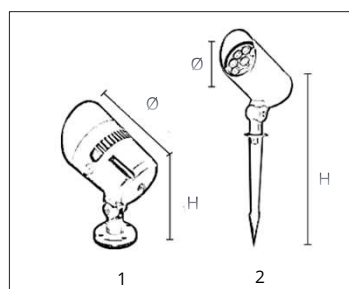

LIGHT DISTRIBUTION

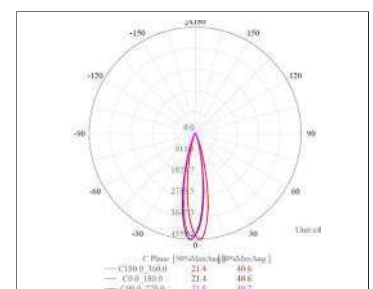

ELGL-3550



APPLICATIONS:

Pathways, Gardens Building
 Facades, Walkways, Driveways
 Signage & Monuments

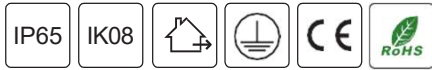

Features

- Rated Life Time: 50,000 Hrs

Optional Features

- Dimming(DALI/1-10V)

PRODUCT PARAMETERS

PHYSICAL	
Housing	Die Cast Aluminum
Diffuser	Toughened glass
Finish	RAL 9005
Mounting	Surface mount / Spike
OPTICAL	
Beam Angle	24°, 38°
UGR	
ELECTRICAL	
CRI	≥90
CCT	3000K/4000K/6000K
Voltage / Frequency	220-240 VAC / 50-60Hz
Operating Temperature	-20°C to +50°C
Driver	In-Built driver

PRODUCT DETAILS

Product Code	Wattage	Lumen	Product Size
ELGL 3550-A	10W	1100 lm	Ø90xH300 mm
ELGL 3550-B	10W	1100 lm	Ø90xH400 mm

PRODUCT DRAWING

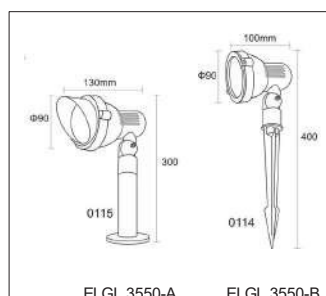

LIGHT DISTRIBUTION

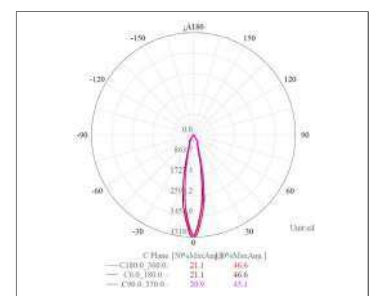





CANOPY LIGHT SERIES

Engineered for reliability and performance, our LED Canopy Light delivers bright, energy-efficient illumination ideal for outdoor and covered spaces such as parking garages, gas stations, loading bays, and walkways. Featuring a rugged, weather-resistant aluminum housing and an impact-resistant polycarbonate lens, it is built to stand harsh environmental conditions.



ELCP-200

ELCP-200



APPLICATIONS:

Parking Garages, Workshops,
Warehouses, Gas Station,
Railway Station & Indoor Stadium



Features

- Higher Lumen Efficiency 140 lm/W
- Rated Life Time: 50,000 Hrs

Optional Features

- Dimming((DALI/1-10V)

PRODUCT PARAMETERS

PHYSICAL	
Housing	Die cast Aluminum
Diffuser	Toughened Glass
Finish	Dark Bronze
Mounting	Surface Mount
OPTICAL	
Beam Angle	110°
UGR	--
ELECTRICAL	
CRI	≥70
CCT	3000K/4000K/5700K
Voltage / Frequency	220-240 VAC / 50-60Hz
Operating Temperature	-20°C to +50°C
Driver	In Built On/Off driver

PRODUCT DETAILS

Product Code	Wattage	Lumen	Product Size
ELCP 200-A	45W	6300 lm	□266xH75 mm
ELCP 200-B	55W	7700 lm	□266xH75 mm
ELCP 200-C	70W	9800 lm	□266xH75 mm

PRODUCT DRAWING

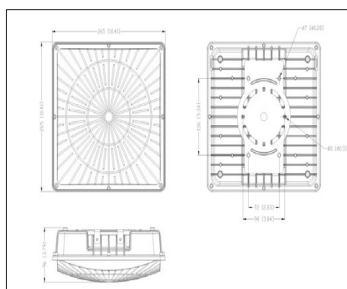

LIGHT DISTRIBUTION

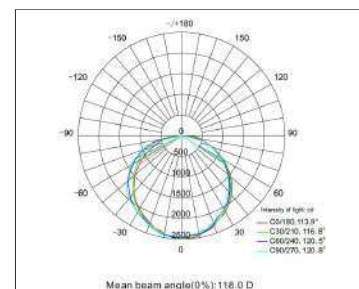





BOLLARD LIGHT SERIES

Bollard Light Series offers a versatile range of architectural lighting solutions designed to enhance outdoor environments with style, safety, and performance. Ideal for pathways, parks, commercial plazas, gardens, and driveways, each model in the series delivers uniform, glare-free illumination tailored for pedestrian visibility and landscape enhancement.



ELBL-E



ELBL-4010



ELBL-4020



ELBL-4030



ELBL-4040



ELBL-4050



ELBL-4060



ELBL-4070



ELBL-4080



ELBL-4090



ELBL-4100



ELBL-4110



ELBL-4120



ELBL-4130



ELBL-4140

ELBL-E



APPLICATIONS:
Landscape & Pathways, Parking
Lots & Public Squares



Features

- Rated Life Time: 50,000 Hrs.
- Customized Size Available

Optional Features

- Dimming (DALI/1-10V)

PRODUCT PARAMETERS

PHYSICAL	
Housing	Aluminum
Diffuser	Acrylic
Finish	RAL 9005
Mounting	Wall top/Ground Surface
OPTICAL	
Beam Angle	360°
UGR	--
ELECTRICAL	
CRI	≥80
CCT	3000K/4000K/6000K/Red/Green/Blue
Voltage / Frequency	220-240 VAC / 50-60Hz
Operating Temperature	-20°C to +50°C
Driver	In Built driver

PRODUCT DETAILS

Product Code	Wattage	Product Size
ELBL E	12W	L250xW250XH300mm

PRODUCT DRAWING

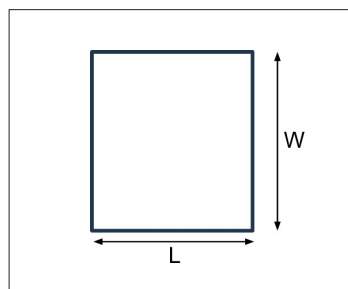

LIGHT DISTRIBUTION

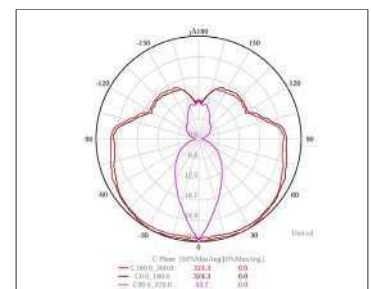

Product specifications are subject to change without prior notice.

ELBL-4010



APPLICATIONS:
Landscape & Pathways, Parking
Lots & Public Squares



Features

- Rated Life Time: 50,000 Hrs.
- Customized Size Available

Optional Features

- Dimming (DALI/1-10V)

PRODUCT PARAMETERS

PHYSICAL	
Housing	Aluminum
Diffuser	Polycarbonate
Finish	Black
Mounting	Ground Surface
OPTICAL	
Beam Angle	360°
UGR	--
ELECTRICAL	
CRI	≥80
CCT	3000K/4000K/6000K//Red/Green/Blue
Voltage / Frequency	220-240 VAC / 50-60Hz
Operating Temperature	-20°C to +50°C
Driver	In Built driver

PRODUCT DETAILS

Product Code	Wattage	Lumen	Product Size
ELBL 4010-1A	10W	1250 lm	W275XH890 mm
ELBL 4010-1B	2x10W	2100 lm	W450xH890 mm

PRODUCT DRAWING

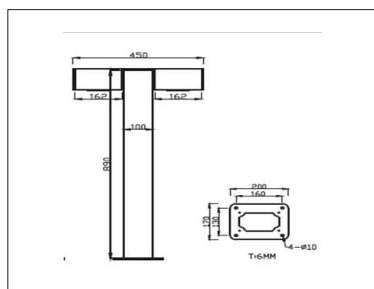

LIGHT DISTRIBUTION

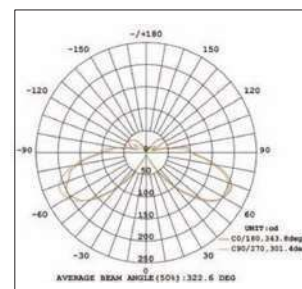

Product specifications are subject to change without prior notice.

ELBL-4030



APPLICATIONS:
Landscape & Pathways, Parking
Lots & Public Squares

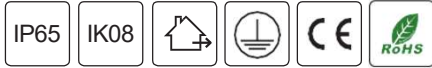

Features

- Rated Life Time: 50,000 Hrs

Optional Features

- Dimming (DALI/1-10V)

PRODUCT PARAMETERS

PHYSICAL	
Housing	Die-cast Aluminum
Diffuser	Clear UV Glass
Finish	Black/Silver
Mounting	Surface Mount
OPTICAL	
Beam Angle	360°
UGR	--
ELECTRICAL	
CRI	≥80
CCT	3000K/4000K/6000K
Voltage / Frequency	220-240 VAC / 50-60Hz
Operating Temperature	-20°C to +50°C
Driver	In Built driver

PRODUCT DETAILS

Product Code	Wattage	Lumen	Product Size
ELBL 4030-A	10W	600 lm	Ø 230xH400 mm
ELBL 4030-B	15W	900 lm	Ø 230xH600 mm
ELBL 4030-C	20W	1200 lm	Ø230xH800 mm

PRODUCT DRAWING

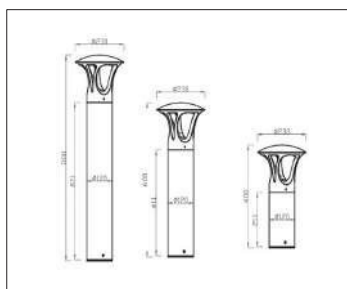

LIGHT DISTRIBUTION

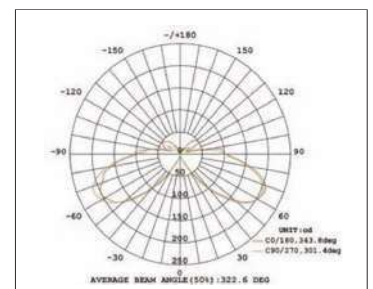

ELBL-4040



APPLICATIONS:
Landscape & Pathways, Parking
Lots & Public Squares

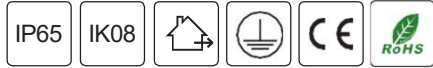

Features

- Rated Life Time: 50,000 Hrs

Optional Features

- Dimming (DALI/1-10V)

PRODUCT PARAMETERS

PHYSICAL	
Housing	Extruded Aluminum Alloy
Diffuser	Clear Anti-UV Glass
Finish	Black/Silver
Mounting	Surface Mount
OPTICAL	
Beam Angle	43°
UGR	--
ELECTRICAL	
CRI	≥80
CCT	3000K/4000K/6000K
Voltage / Frequency	220-240 VAC / 50-60Hz
Operating Temperature	-20°C to +50°C
Driver	In Built driver

PRODUCT DETAILS

Product Code	Wattage	Lumen	Product Size
ELBL 4040-A	10W	617 lm	150x800
ELBL 4040-B	14W	910 lm	150x800

PRODUCT DRAWING

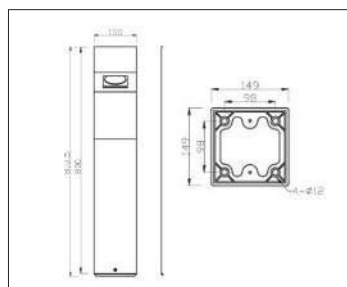

LIGHT DISTRIBUTION

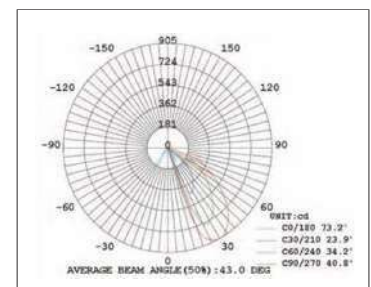

ELBL-4050



APPLICATIONS:
Landscape & Pathways, Parking
Lots & Public Squares



Features

- Rated Life Time: 50,000 Hrs.

Optional Features

- Dimming (DALI/1-10V)
- Customized Size Available

PRODUCT PARAMETERS

PHYSICAL	
Housing	Die-cast Aluminum
Diffuser	Polycarbonate
Finish	Graphite / Black
Mounting	Surface mount
OPTICAL	
Beam Angle	120°
UGR	--
ELECTRICAL	
CRI	≥80
CCT	3000K/4000K/6000K/Red/Green/Blue
Voltage / Frequency	220-240 VAC / 50-60Hz
Operating Temperature	-20°C to +50°C
Driver	In Built driver

PRODUCT DETAILS

Product Code	Wattage	Lumen	Product Size
ELBL 4050-A	10W	1000 lm	150xH400mm
ELBL 4050-B	20W	2000 lm	150xH400mm
ELBL-4050-C	10W	1000 lm	150xH800mm
ELBL 4050-D	20W	2000 lm	150xH800mm

PRODUCT DRAWING

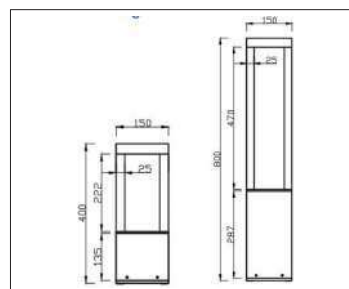

LIGHT DISTRIBUTION

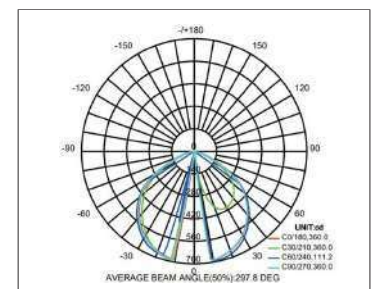

ELBL-4060



APPLICATIONS:
Landscape & Pathways, Parking
Lots & Public Squares

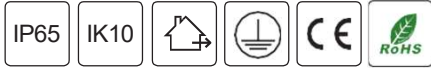

Features

- Rated Life Time: 50,000 Hrs

Optional Features

- Dimming (DALI/1-10V)

PRODUCT PARAMETERS

PHYSICAL	
Housing	Aluminum
Diffuser	Opal Polycarbonate
Finish	9007 Graphite / 9005 Black
Mounting	Surface mount
OPTICAL	
Beam Angle	120°
UGR	--
ELECTRICAL	
CRI	≥90
CCT	3000K/4000K/6000K
Voltage / Frequency	220-240 VAC / 50-60Hz
Operating Temperature	-20°C to +50°C
Driver	In Built driver

PRODUCT DETAILS

Product Code	Wattage	Lumen	Product Size
ELBL 4060-A	6W	660 lm	150xH800 mm
ELBL 4060-B	12W	1320 lm	150xH800 mm
ELBL-4060-C	15W	1650 lm	250xH310 mm
ELBL 4060-D	10W	1100 lm	120xH400 mm
ELBL 4060-E	10W	1100 lm	120xH600 mm
ELBL 4060-F	10W	1100 lm	120xH800 mm
ELBL 4060-G	12W	1320 lm	150xH400 mm
ELBL 4060-H	12W	1320 lm <td 150xH600 mm	
ELBL 4060-I	12W	1320 lm	150xH600 mm

PRODUCT DRAWING

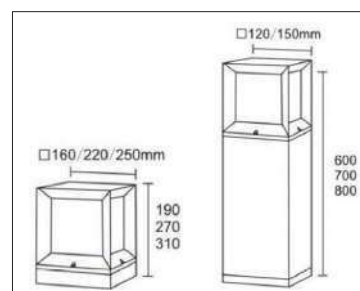

LIGHT DISTRIBUTION

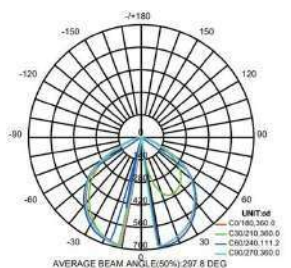

ELBL-4070



APPLICATIONS:
Landscape & Pathways, Parking
Lots & Public Squares



Features

- Rated Life Time: 50,000 Hrs.

Optional Features

- Dimming (DALI/1-10V)

PRODUCT PARAMETERS

PHYSICAL	
Housing	Die-cast Aluminum
Diffuser	Transparent Polycarbonate
Finish	9007 Graphite /9005 Black
Mounting	Surface Mount
OPTICAL	
Beam Angle	360°
UGR	--
ELECTRICAL	
CRI	≥90
CCT	3000K/4000K/6000K
Voltage / Frequency	220-240 VAC / 50-60Hz
Operating Temperature	-20°C to +50°C
Driver	In Built driver

PRODUCT DETAILS

Product Code	Wattage	Lumen	Product Size
ELBL 4070-A	10W	1200 lm	Ø120xH600 mm
ELBL 4070-B	10W	1200 lm	Ø120xH700 mm
ELBL 4070-C	12W	1440 lm	Ø140xH600 mm
ELBL 4070-D	12W	1440 lm	Ø140xH800 mm
ELBL 4070-E	16W	1920 lm	Ø180xH600 mm
ELBL 4070-F	16W	1920 lm	Ø180xH800 mm
ELBL 4070-G	12W	1440 lm	Ø140xH250 mm
ELBL 4070-H	16W	1920 lm	Ø180xH250 mm
ELBL 4070-I	16W	1920 lm	Ø 220xH250 mm

PRODUCT DRAWING

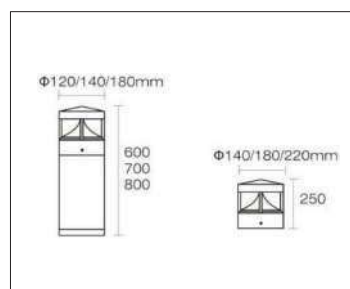

LIGHT DISTRIBUTION

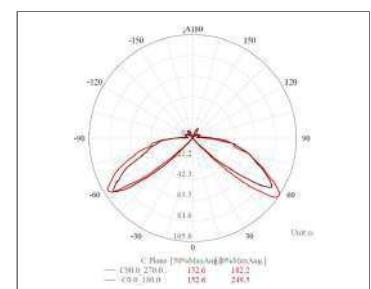

ELBL- 4080



APPLICATIONS:
Landscape & Pathways, Parking
Lots & Public Squares

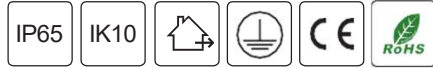

Features

- Rated Life Time: 50,000 Hrs.

Optional Features

- Dimming (DALI/1-10V)
- Emergency Back up

PRODUCT PARAMETERS

PHYSICAL	
Housing	Die-cast Aluminum
Diffuser	Transparent Polycarbonate
Finish	9007 Graphite /9005 Black
Mounting	Surface Mount
OPTICAL	
Beam Angle	180°
UGR	--
ELECTRICAL	
CRI	≥90
CCT	3000K/4000K/6000K
Voltage / Frequency	220-240 VAC / 50-60Hz
Operating Temperature	-20°C to +50°C
Driver	In Built driver

PRODUCT DETAILS

Product Code	Wattage	Lumen	Product Size
ELBL 4080-A	10W	1200 lm	Ø120xH600 mm
ELBL 4080-B	10W	1200 lm	Ø120xH700 mm
ELBL 4080-C	12W	1440 lm	Ø140xH250 mm
ELBL 4080-D	12W	1440 lm	Ø140xH600 mm
ELBL 4080-E	12W	1440 lm	Ø140xH800 mm
ELBL 4080-F	16W	1920 lm	Ø180xH250 mm
ELBL 4080-G	16W	1920 lm	Ø180xH600 mm
ELBL 4080-H	16W	1920 lm	Ø180xH800 mm

PRODUCT DRAWING

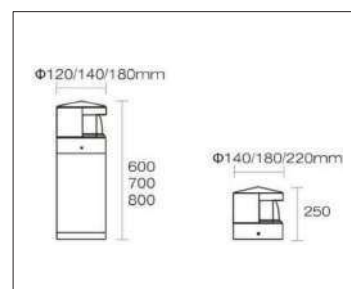

LIGHT DISTRIBUTION

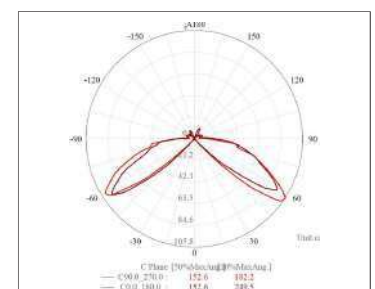

ELBL-4090



APPLICATIONS:
Landscape & Pathways, Parking
Lots & Public Squares

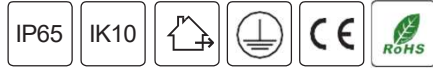

Features

- Rated Life Time: 50,000 Hrs
- Solar-Powered Operation
- Automatic Dusk-to-Dawn Lighting
- Maintenance-Free Operation

Optional Features

- Dimming

PRODUCT PARAMETERS

PHYSICAL	
Housing	Die cast Aluminum
Diffuser	Polycarbonate
Finish	Black/Dark Gray
OPTICAL	
Beam Angle	360°
ELECTRICAL	
Power	1.2W
Lumen	>280 lm
Battery Type	LiFeP04 32700 6000mA 3.2V 12AH
CRI	≥80
Working Mode	2H 100%+13H 30%
CCT	3000K/4000K/6000K
Operating Temperature	-20°C to +50°C
Solar Panel	5V,6.2W Mono
Sensor Type	Microwave Sensor
Detection Distance	4-6 Meters
Detection Angle	360°
Control method	Automatic Dusk to Dawn

PRODUCT DRAWING

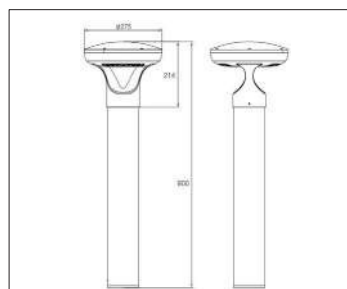

LIGHT DISTRIBUTION

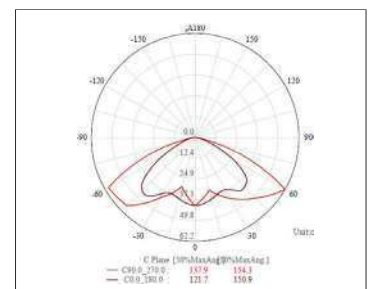

ELBL-4100



APPLICATIONS:
Landscape & Pathways, Parking
Lots & Public Squares

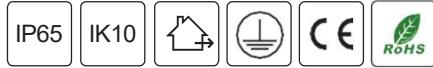

Features

- Rated Life Time: 50,000 Hrs
- Solar-Powered Operation
- Automatic Dusk-to-Dawn Lighting
- Maintenance-Free Operation

Optional Features

- Dimming

PRODUCT PARAMETERS

PHYSICAL	
Housing	Die cast Aluminum
Diffuser	Tempered Glass
Finish	Black 9011/Anthracite Gray 7016
OPTICAL	
Beam Angle	180°
ELECTRICAL	
Power	1.2W
Lumen	>280 lm
Battery Type	LiFePO4 32700 6000mA 3.2V 38.4WH
CRI	≥80
Working Mode	2H 100%+13H 30%
CCT	3000K/4000K/6000K
Operating Temperature	4.5 hours & >36 hours
Solar Panel	-20°C to +50°C
Sensor Type	5V,6.2W Mono
Detection Distance	Microwave Sensor
Detection Angle	8 Meters
Control method	Automatic Dusk to Dawn

PRODUCT DRAWING

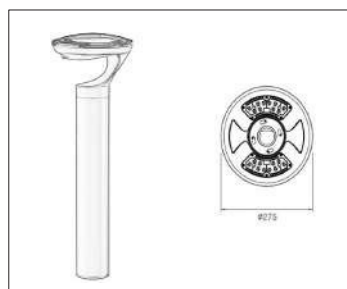

LIGHT DISTRIBUTION

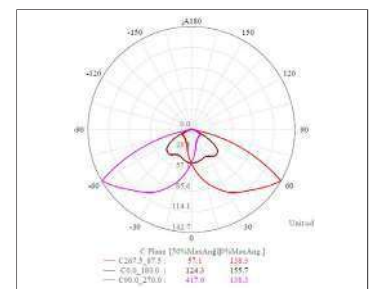

ELBL-4110



APPLICATIONS:
Landscape & Pathways, Parking
Lots & Public Squares

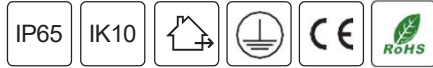

Features

- Rated Life Time: 50,000 Hrs
- Solar-Powered Operation
- Automatic Dusk-to-Dawn Lighting
- Maintenance-Free Operation

Optional Features

- Dimming

PRODUCT PARAMETERS

PHYSICAL	
Housing	Die cast Aluminum
Diffuser	Polycarbonate
Finish	Black/Dark Gray
OPTICAL	
Beam Angle	360°
ELECTRICAL	
Power	1.2W
Lumen	>280 lm
Battery Type	LiFePO4 32700 6000mA 3.2V 12AH
CRI	≥80
Working Mode	2H 100%+13H 30%
CCT	3000K/4000K/6000K
Operating Temperature	-20°C to +50°C
Solar Panel	5V,6.2W Mono
Sensor Type	Microwave Sensor
Detection Distance	4-6 Meters
Detection Angle	360°
Control method	Automatic Dusk to Dawn

PRODUCT DRAWING

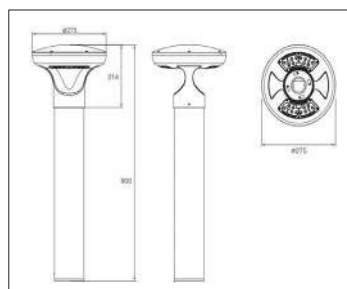

LIGHT DISTRIBUTION

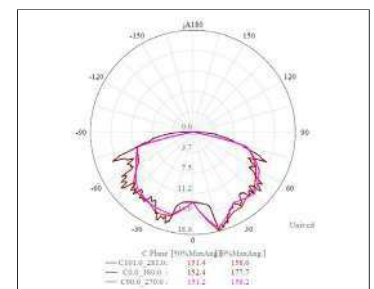

ELBL-4120



APPLICATIONS:
Landscape & Pathways, Parking
Lots & Public Squares



Features

- Rated Life Time: 50,000 Hrs.

Optional Features

- Dimming (DALI/1-10V)

PRODUCT DETAILS

Product Code	Wattage	Lumen	Product Size
ELBL-4120 – A	10W	1100 lm	Ø108xH600 mm
ELBL 4120 – B	10W	1100 lm	Ø108xH700 mm
ELBL 4120 - C	12W	1320 lm	Ø145xH600 mm
ELBL 4120 – D	12W	1320 lm	Ø145xH800 mm
ELBL 4120 – E	12W	1320 lm	Ø160xH300 mm
ELBL 4120 – F	12W	1320 lm	Ø160xH600 mm
ELBL 4120-G	12W	1320 lm	Ø160xH800 mm

PHYSICAL	
Housing	Die-cast Aluminum
Diffuser	Clear Polycarbonate
Finish	9007 Graphite / 9005 Black
Mounting	Surface mount
OPTICAL	
Beam Angle	360°
UGR	--
ELECTRICAL	
CRI	≥90
CCT	3000K/4000K/6000K
Voltage / Frequency	220-240 VAC / 50-60Hz
Operating Temperature	-20°C to +50°C
Driver	In Built driver

PRODUCT DRAWING

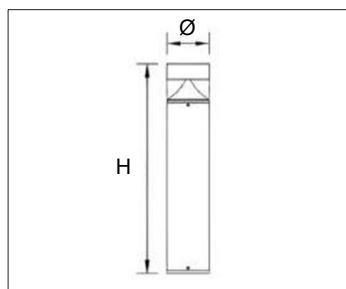

LIGHT DISTRIBUTION

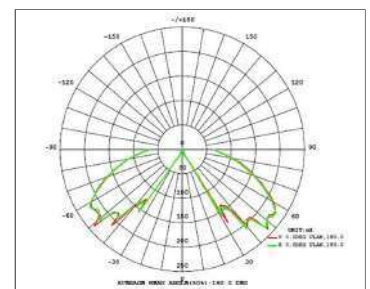

Product specifications are subject to change without prior notice.

ELBL-4130



APPLICATIONS:
Landscape & Pathways, Parking
Lots & Public Squares



Features

- Rated Life Time: 50,000 Hrs.

Optional Features

- Dimming (DALI/1-10V)

PRODUCT PARAMETERS

PHYSICAL	
Housing	Die-cast Aluminum
Diffuser	Transparent Polycarbonate
Finish	9007 Graphite / 9005 Black
Mounting	Surface mount
OPTICAL	
Beam Angle	360°
ELECTRICAL	
CRI	≥90
CCT	3000K/4000K/6000K
Voltage/Frequency	220-240 VAC / 50-60Hz
Operating Temperature	-20°C to +50°C
Driver	In Built driver
Wattage	8W

PRODUCT DETAILS

Product Code	Wattage	Lumen	Product Size
ELBL-4130 A	9W	522lm	Ø165xH300 mm
ELBL 4130 B	9W	522lm	Ø165xH600 mm
ELBL 4130 C	9W	522lm	Ø165xH800 mm

PRODUCT DRAWING

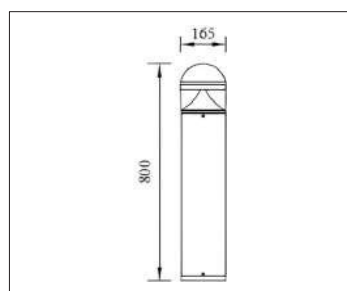

LIGHT DISTRIBUTION

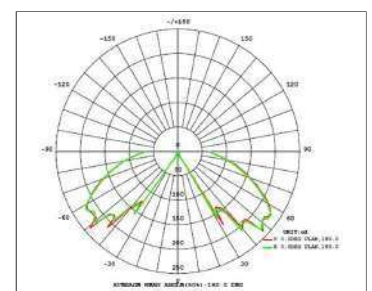

ELBL-4140



APPLICATIONS:
Landscape & Pathways, Parking
Lots & Public Squares



Features

- Rated Life Time: 50,000 Hrs.

Optional Features

- Dimming (DALI/1-10V)

PRODUCT PARAMETERS

PHYSICAL	
Housing	Die-cast Aluminum
Diffuser	Transparent Polycarbonate
Finish	9007 Graphite / 9005 Black
Mounting	Surface mount
OPTICAL	
Beam Angle	360°
ELECTRICAL	
CRI	≥90
CCT	3000K/4000K/6000K
Voltage/Frequency	220-240 VAC / 50-60Hz
Operating Temperature	-20°C to +50°C
Driver	In Built driver
Wattage	12W

PRODUCT DETAILS

Product Code	Wattage	Lumen	Product Size
ELBL4140 -A	12W	820lm	□150x300 mm
ELBL 4140 -B	12W	820lm	□150x600 mm
ELBL 4140 -C	12W	820lm	□150x800 mm

PRODUCT DRAWING

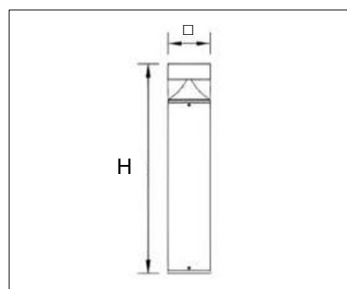

LIGHT DISTRIBUTION

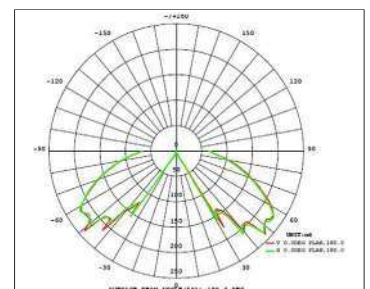

Product specifications are subject to change without prior notice.

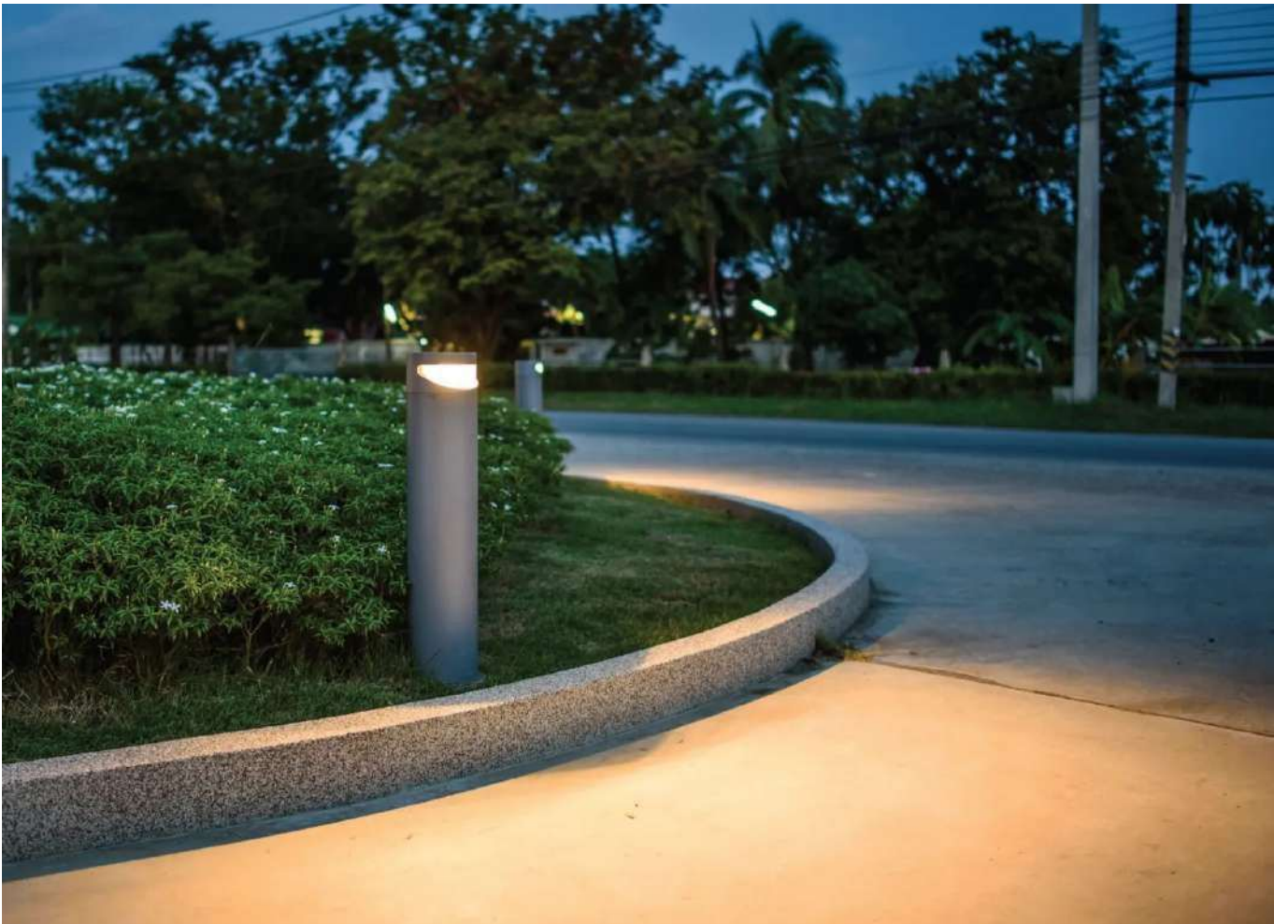



WEATHER PROOF LED LIGHT SERIES

The Weather Proof LED Light Series is engineered for maximum durability and performance in the toughest environments. Designed to be waterproof, dustproof, and corrosion-resistant, these lights are ideal for industrial, commercial, and outdoor applications where standard lighting can't withstand the elements.



EWP-NPC



EWP-MAL



EWP-603



EWP-604



EWP-605

EWP-NPC



APPLICATIONS:

Industrial Factories, Parking
Garages, Basements, Cold Storage,
Basements, Agricultural Facilities,
Warehouse & Logistics Centers



Features

- Corrosion Resistant Housing
- Easy Mounting & Maintenance
- 50,000 hrs. Life time
- Concentrated Light
- High Lumen Efficiency 130-150 lm/W

Optional Features

- Dimming (DALI/1-10V)
- Emergency Back up

PRODUCT PARAMETERS

PHYSICAL	
Housing	Polycarbonate
Diffuser	UV Stabilized Polycarbonate
Finish	Grey
Mounting	Surface/Suspended/Pole Mount
OPTICAL	
Beam Angle	120°
UGR	--
ELECTRICAL	
CRI	≥70
CCT	3000K/4000K/6000K
Voltage / Frequency	220-240 VAC / 50-60Hz
Operating Temperature	-20°C to +50°C
Driver	In Built

PRODUCT DETAILS

Product Code	Wattage	Lumen	Product Size
EWP NPC	8W	1040 lm	L665xW84xH98.5 mm
	12W	1800 lm	L665xW84xH98.5 mm
	18W	2400 lm	L665xW84xH98.5 mm
	24W	3000 lm	L665xW84xH98.5 mm
	28W	4200 lm	L1275xW84xH98.5 mm
	32W	4800 lm	L1275xW84xH98.5 mm
	40W	6000 lm	L1275xW84xH98.5 mm
	36W	5400 lm	L1275xW134xH98.5 mm
	40W	6000 lm	L1275xW134xH98.5 mm
	47W	7050 lm	L1275xW134xH98.5 mm
	52W	7800 lm	L1275xW134xH98.5 mm
	58W	8700 lm	L1275xW134xH98.5 mm
	62W	9300 lm	L1275xW134xH98.5mm

PRODUCT DRAWING

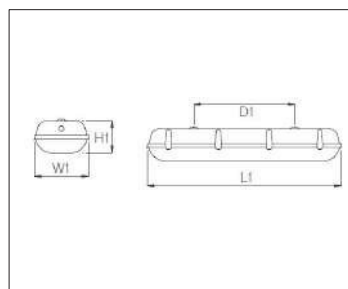

LIGHT DISTRIBUTION

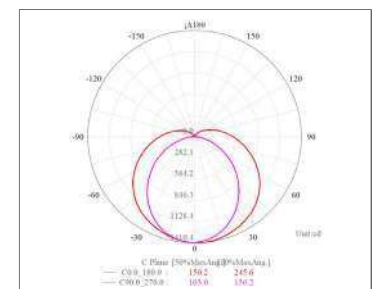

EWP- MAL



APPLICATIONS:

Industrial Factories, Parking
Garages, Basements, Cold Storage,
Basements, Agricultural Facilities,
Warehouse & Logistics Centers



Features

- Corrosion Resistant Housing
- Easy Mounting & Maintenance
- 50,000 hrs. Life time
- Concentrated Light
- High Lumen Efficiency 130 lm/W

Optional Features

- Dimming (DALI/1-10V)
- Emergency Back up

PRODUCT PARAMETERS

PHYSICAL	
Housing	Extruded Aluminum
Diffuser	Polycarbonate
Finish	Silver
Mounting	Ceiling Mount / Suspended
OPTICAL	
Beam Angle	120°
UGR	--
ELECTRICAL	
CRI	≥80
CCT	4000K/6000K
Voltage / Frequency	220-240 VAC / 50-60Hz
Operating Temperature	-20°C to +50°C
Driver	In Built

PRODUCT DETAILS

Product Code	Wattage	Lumen	Product Size
EWP MAL	20W	2600 lm	L625xW86xH68 mm
	28W	3600 lm	L625xW86xH68 mm
	38W	5000 lm	L1185xW86xH68 mm
	46W	6500 lm	L1465xW86xH68 mm
	54W	7500 lm	L1745xW86xH68 mm
	64W	8700 lm	L1465xW86xH68 mm

PRODUCT DRAWING

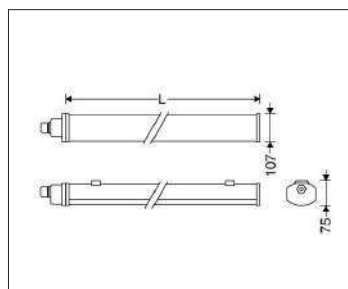

LIGHT DISTRIBUTION

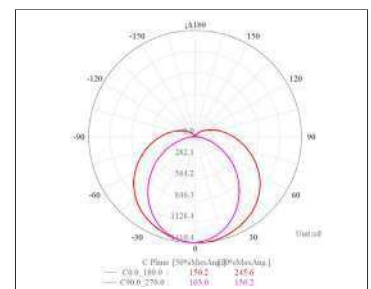

EWP-603



APPLICATIONS:

Industrial Factories, Parking
Garages, Basements, Cold Storage,
Basements, Agricultural Facilities,
Warehouse & Logistics Centers

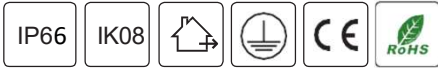

Features

- Corrosion Resistant Housing
- Easy Mounting & Maintenance
- 50,000 hrs. Life time
- Concentrated Light
- High Lumen Efficiency 165 lm/W

Optional Features

- Dimming (DALI/1-10V)
- Emergency Back up

PRODUCT PARAMETERS

PHYSICAL	
Housing	Stainless Steel
Diffuser	PMMA
Finish	-
Mounting	Ceiling Mount / Suspended
OPTICAL	
Beam Angle	120°
UGR	--
ELECTRICAL	
CRI	≥80
CCT	4000K/6000K
Voltage / Frequency	220-240 VAC / 50-60Hz
Operating Temperature	-20°C to +50°C
Driver	In Built

PRODUCT DETAILS

Product Code	Wattage	Lumen	Product Size
EWP 603-A	20W	3300 lm	A600xB650xC656xD700xE542
EWP 603-B	40W	6600 lm	A1128xB1178xC1184xD1228xE1070
EWP 603-C	50W	8250 lm	A1390xB1440xC1446xD1490xE1332
EWP 603-D	75W	12,375 lm	A1390xB1440xC1446xD1490xE1332

PRODUCT DRAWING

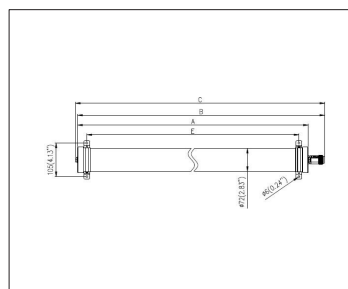

LIGHT DISTRIBUTION

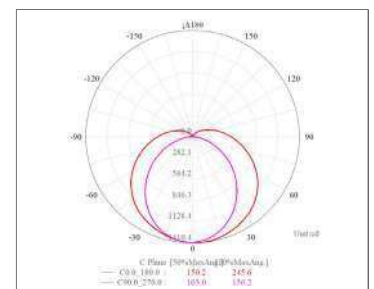

EWP-604

APPLICATIONS:

Plant Rooms, Warehouses, Open & Closed Parking Areas, Workstation, Corridors, Cellars & Sheds



Features

- Corrosion Resistant Housing
- Easy Mounting & Maintenance
- 50,000 hrs. Life time
- High Lumen Efficiency 120 lm/W

Optional Features

- Dimming (DALI/1-10V)
- Emergency Back up

PRODUCT PARAMETERS

PHYSICAL	
Housing	Stainless Steel
Diffuser	Frosted glass Diffuser
Finish	Stainless steel Finish
Mounting	Surface Mount
OPTICAL	
Beam Angle	120°
UGR	--
ELECTRICAL	
CRI	≥80
CCT	3000K/4000K/6000K
Voltage / Frequency	220-240 VAC / 50-60Hz
Operating Temperature	-20°C to +50°C
Driver	In Built

PRODUCT DETAILS

Product Code	Wattage	Lumen	Product Size
EWP 604-A	100W	12000 lm	L1300xW140xH90 mm

PRODUCT DRAWING

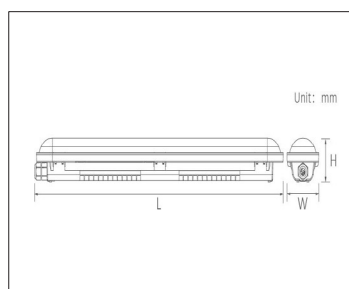

LIGHT DISTRIBUTION

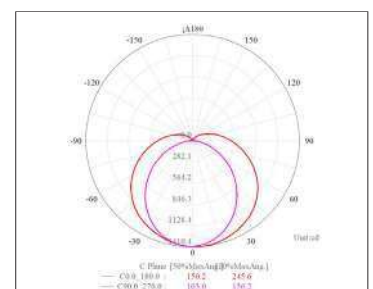

EWP-605



APPLICATIONS:

Plant Rooms, Warehouses, Open & Closed Parking Areas, Workstation, Corridors, Cellars & Sheds



Features

- Easy Mounting & Maintenance
- 50,000 Hrs. Life time
- Higher Lumen Efficiency 100 lm/W

Optional Features

- Dimming (DALI/1-10V)
- Microwave Sensor
- Emergency Back up

PRODUCT PARAMETERS

PHYSICAL	
Housing	Extruded Aluminum
Diffuser	Tempered glass
Finish	Grey
Mounting	Surface Mount
OPTICAL	
Beam Angle	120°
UGR	--
ELECTRICAL	
CRI	≥80
CCT	3000K/4000K/6000K
Voltage / Frequency	220-240 VAC / 50-60Hz
Operating Temperature	-20°C to +50°C
Driver	In Built

PRODUCT DETAILS

Product Code	Wattage	Lumen	Product Size
EWP 605-A	20W	2000 lm	L580xW104xH98mm
EWP 605-B	30W	3000 lm	L840xW104xH98mm
EWP 605-C	40W	4000 lm	L1100xW104xH98mm

PRODUCT DRAWING

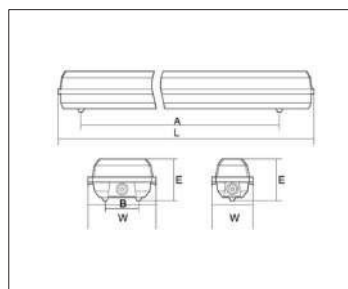

LIGHT DISTRIBUTION

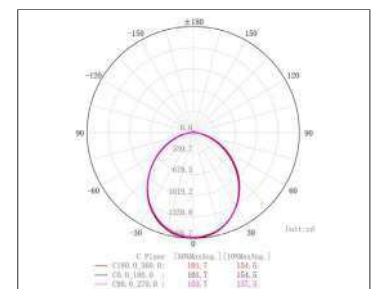





SEARCH LIGHT SERIES

Designed for performance and reliability, our Marine Searchlight offers powerful, long-range visibility to enhance navigation, safety, and security aboard any vessel. Whether you're patrolling, docking at night, or conducting search and rescue, this rugged lighting system delivers dependable illumination under the toughest marine conditions.



ELSE-650



ELSE-651

ELSE-650

APPLICATIONS:
Navigation Aid, Security & Patrol
& Emergency Signaling



Features

- Shell is made of good Stainless Steel
- 350° horizontally adjustable
- Far Illumination Distance
- Concentrated Light
- Halogen Lamp Source

key features of cabin pedestal

- Stable Mounting
- Rotational Movement
- Size L234xH310 mm

PRODUCT PARAMETERS

PHYSICAL	
Housing	Stainless Steel
Diffuser	Toughened Glass
Finish	-
Mounting	Surface Mount
OPTICAL	
UGR	--
ELECTRICAL	
CRI	--
CCT	--
Voltage / Frequency	220-240 VAC / 50-60Hz
Operating Temperature	-20°C to +50°C
Driver	--

PRODUCT DETAILS

Product Code	Wattage	Lumen	Lamp Hoder	Product Size
ELSE 650-A	300W	6900 lm	GY 9.5	L400xW390XH530 mm
ELSE 650-B	500W	12500 lm	GY 9.5	L400xW390XH530 mm
ELSE 650-C	1000W	23000 lm	GX9.5	L400xW390XH530 mm
ELSE 650-D	2000W	53000 lm	GY 16	L521xW463xH724 mm

PRODUCT DRAWING

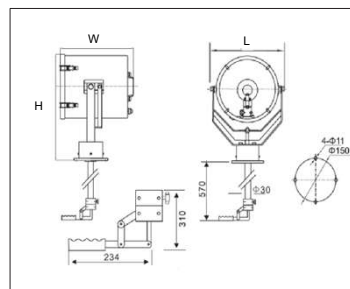

LIGHT DISTRIBUTION

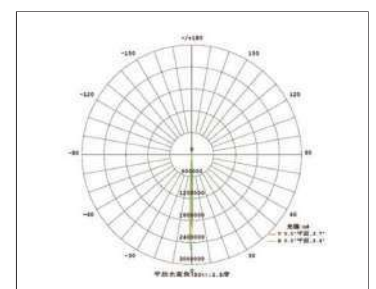

ELSE-651



APPLICATIONS:
Ships, Dock Port, Store Place
& Stadium



Features

- Shell is made of good Stainless Steel
- 350° horizontally adjustable
- Far Illumination Distance
- Concentrated Light

key features of cabin pedestal

- Stable Mounting
- Rotational Movement

Optional Features

- Dimming (DALI/1-10V)

PRODUCT PARAMETERS

PHYSICAL	
Housing	Stainless Steel
Diffuser	Toughened Glass
Finish	White
Mounting	Surface Mount
OPTICAL	
Exposure Distance	1000m
UGR	--
ELECTRICAL	
CRI	≥80
CCT	5700K
Voltage / Frequency	220-240 VAC / 50-60Hz
Operating Temperature	-20°C to +50°C
Driver	In Built

PRODUCT DETAILS

Product Code	Wattage	Product Size
ELSE 651-A	150W	L371xW220XH513 mm

PRODUCT DRAWING

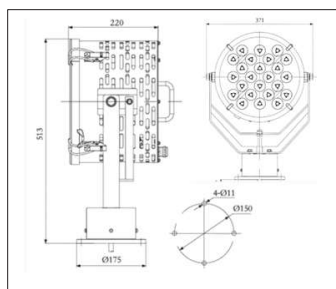

LIGHT DISTRIBUTION

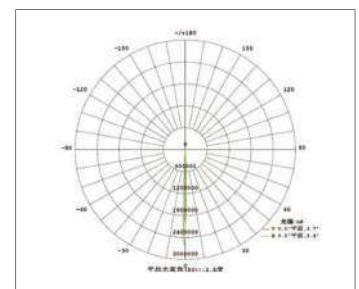



SOLAR LIGHT SERIES

Solar Light Series is a sustainable, energy-efficient lighting solution designed to provide reliable illumination in outdoor environments without the need for electrical wiring.

Powered by high-efficiency solar panels and long-life lithium batteries, this series offers eco-friendly performance while reducing Mounting and operating costs.



ELFS-120



ELFS-121

ELFS-120



APPLICATIONS:
Highways, Roads, Parks, Public
Spaces & Parking Lots



Features

- Higher Lumen Efficiency 170 lm/W
- Rated Life Time: 50,000 Hrs
- Motion Sensor and smart Controller

Optional Features

- Dimming

PRODUCT PARAMETERS

PHYSICAL	
Housing	Diecast Aluminium
Diffuser	Polycarbonate Lens
Finish	Black/Grey
Mounting	Post top
OPTICAL	
Beam Angle	Asymmetrical
UGR	--
ELECTRICAL	
CRI	≥70(≥80 upon request)
CCT	3000K/4000K/5000K/6500K
Battery Volt	3.2/12.8/25.6V
Operating Temperature	-20°C to +50°C
Driver	--

PRODUCT DETAILS

Product Code	Wattage	Lumen	Battery Rating & Power	Product Size
ELFS 120-A	20/30W	3400/5100 lm	3.2V/75 AH,240 WH	L675xW418xH289 mm
ELFS 120-B	40/50W	6800/8500 lm	12.8V/30AH,384WH	L999xW418xH289 mm
ELFS 120-C	60/80W	10020/13600 lm	25.6V/15AH,384WH	L1159xW418xH289 mm
ELFS 120-D	100W	17000 lm	25.6V/30AH,768WH	L1503xW418xH379 mm

PRODUCT DRAWING

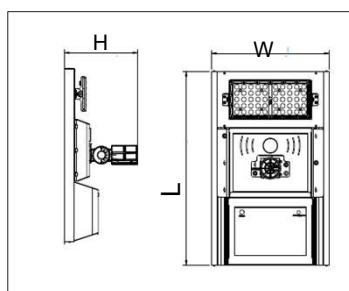

LIGHT DISTRIBUTION

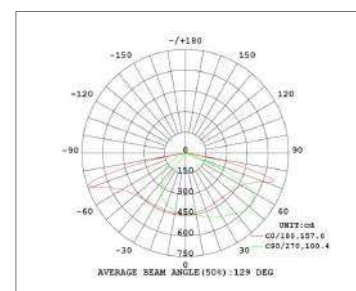

ELFS-121

APPLICATIONS:
Streets, Gardens, Parks, Villas,
& Community Schools



Features

- 360 ° Solar Module Orientation
- High Photoelectric Conversion Efficiency
- Easy Maintenance
- Multiple Models

Optional Features

- Dimming

PRODUCT PARAMETERS

PHYSICAL	
Housing	Diecast Aluminium
Mounting Way	Base Plate
ELECTRICAL	
CRI	>70
Solar Panel Wattage	80W
Lumen	3000lm
CCT	3000K / 4000K / 6000K
Battery(Life PO4)	320 WH
Charging Time	6-8 Hrs.
Back Up time	3 Nights
Operating Temperature	-20°C to +65°C
Lighting Mode	Dimming Mode in default
Pole Height	3 Meter
Pole Material	Hardened Galvanized Steel

LIGHT DISTRIBUTION

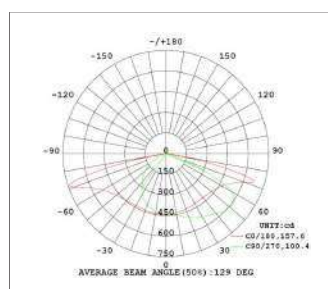



UNDER WATER LIGHT SERIES

Our underwater LED light combines superior brightness with robust waterproof performance, making it ideal for enhancing visibility and ambiance in submerged environments. Built with corrosion-resistant materials and energy-efficient technology, this fixture is perfect for pools, fountains, aquariums, and marine Mounting s.



ELUW-6910

ELUW-6910



APPLICATIONS:
Public Parks, Hotel and
resort Landscapes,
Swimming Pool



Features

- High Level of Protection against Corrosion
- Adjustable Mounting Bracket

Optional Features

- Dimming (DALI/1-10V)

PRODUCT PARAMETERS

PHYSICAL	
Housing	Stainless Steel 304
Diffuser	Anti Glare Optical Lens
Finish	Stainless Steel
Mounting	Recessed
OPTICAL	
Beam Angle	15°/30°/60°
UGR	--
ELECTRICAL	
CRI	≥70
CCT	3000K/4000K/5000K/6500K
Voltage / Frequency	24Vdc
Operating Temperature	-20°C to +50°C
Driver	Remote

PRODUCT DETAILS

Product Code	Wattage	Lumen	Product Size
ELUW 6910-A	6W	510 lm	Ø145xH60 mm
ELUW 6910-B	12W	1002 lm	Ø188xH61 mm
ELUW 6910-C	20W	1700 lm	Ø280xH81 mm

PRODUCT DRAWING

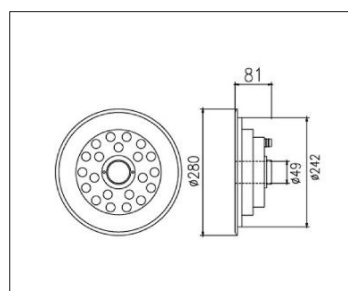

LIGHT DISTRIBUTION

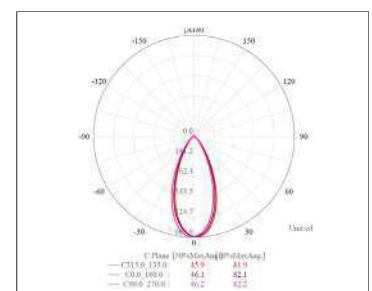

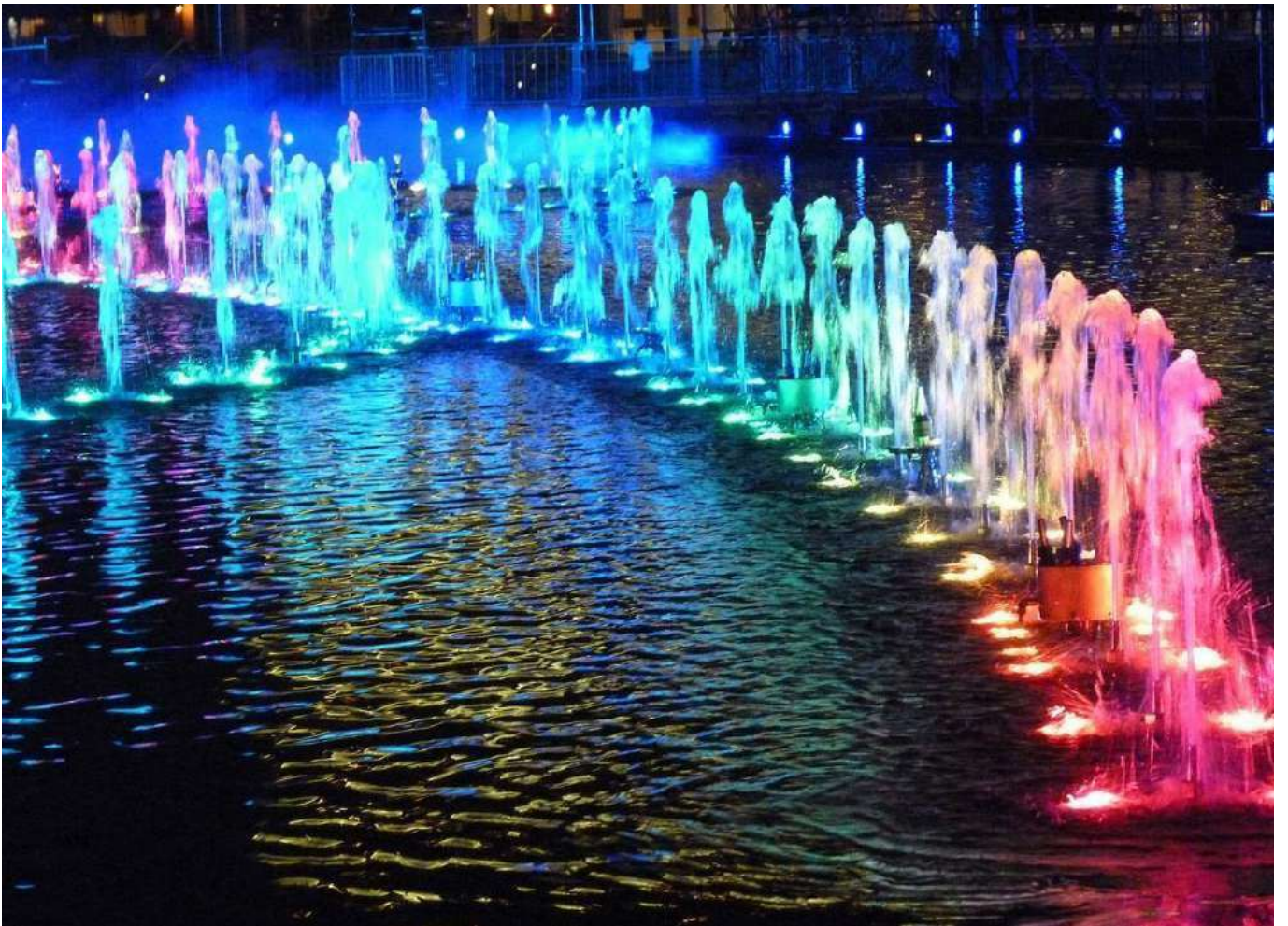



LED TUNNEL LIGHT SERIES

LED Tunnel Light Series is engineered to deliver powerful, uniform illumination for tunnels, underpasses, and other demanding environments requiring continuous, high visibility lighting. Designed with safety, energy efficiency, and durability in mind, each fixture in the series ensures optimal light distribution to reduce glare and enhance driver visibility.



ELTN-300



ELTN-301

ELTN-300



APPLICATIONS:

Highways Tunnels, Undersea
Tunnels, Underpasses & Subways



Features

- Higher Lumen Efficiency 130 lm/W
- High Level of Protection against Corrosion
- Adjustable Mounting Bracket

Optional Features

- Dimming (DALI/1-10V)

PRODUCT PARAMETERS

PHYSICAL	
Housing	Aluminum
Diffuser	Anti Glare Optical Lens
Finish	Black
Mounting	Surface/Suspended
OPTICAL	
Beam Angle	15°/30°/60°/90°/120°/ASY1
UGR	--
ELECTRICAL	
CRI	≥70
CCT	3000K/4000K/5000K/5700K/6500K
Voltage / Frequency	220-240 VAC / 50-60Hz
Operating Temperature	-20°C to +50°C
Driver	--

PRODUCT DETAILS

Product Code	Wattage	Lumen	Product Size
ELTN 300-A	30W	3900 lm	L323xW217 xH127.5 mm
ELTN 300-B	50W	6500 lm	L323xW217xH127.5 mm
ELTN 300-C	80W	10040 lm	L323xW217 xH127.5 mm
ELTN 300-D	100W	13000 lm	L323xW217xH127.5 mm
ELTN 300-E	120W	15600 lm	L423xW217xH127.5 mm
ELTN 300-F	150W	19500 lm	L423xW217xH127.5 mm
ELTN 300-G	180W	23400 lm	L623xW217xH127.5 mm
ELTN 300-H	200W	26000 lm	L623xW217xH127.5 mm
ELTN 300-1	240W	31200 lm	L623xW217xH127.5 mm

PRODUCT DRAWING

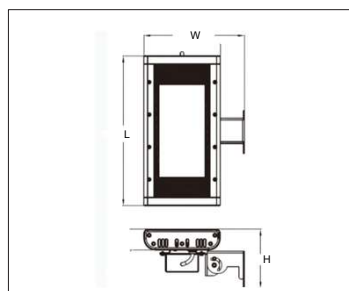

LIGHT DISTRIBUTION

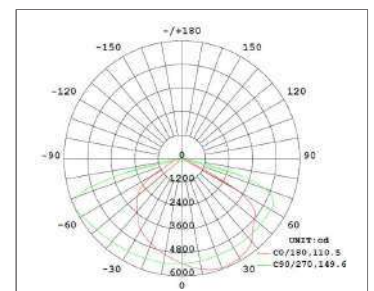

ELTN-301

APPLICATIONS:

Highways Tunnels, Undersea
Tunnels, Underpasses & Subways



Features

- Higher Lumen Efficiency 165 lm/W
- High Level of Protection against Corrosion
- Adjustable Mounting Bracket

Optional Features

- Dimming (DALI/1-10V)

PRODUCT PARAMETERS

PHYSICAL Aluminium	
Housing	Aluminum
Diffuser	PMMA
Finish	Black /Grey
Mounting	Surface/ Suspended
OPTICAL	
Beam Angle	Asymmetrical
UGR	--
ELECTRICAL	
CRI	≥70
CCT	3000K/4000K/5000K/5700K/6500K
Voltage / Frequency	220-240 VAC / 50-60Hz
Operating Temperature	-20°C to +50°C
Driver	--

PRODUCT DETAILS

Product Code	Wattage	Lumen	Product Size
ELTN 301-A	60/100W	9900/16500 lm	L1123xW80 mm

PRODUCT DRAWING

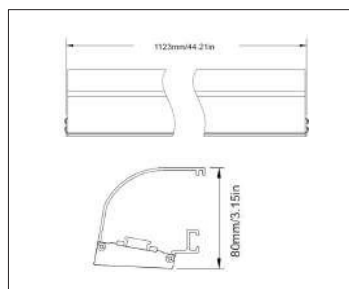

LIGHT DISTRIBUTION

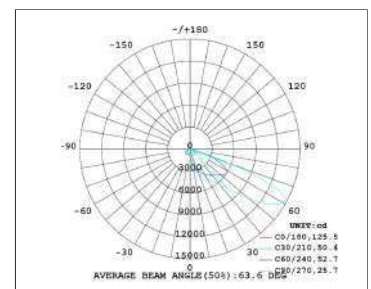



STEP LIGHT SERIES

Step Light Series is designed to provide elegant, low-glare illumination for stairs, walkways, and walls—enhancing both safety and aesthetics in residential, commercial, and hospitality spaces. These discreet fixtures offer soft, focused light that guides movement while creating a warm and inviting atmosphere.



ELSP-1550



ELWL-1551



ELSP-1552



ELSP-1553

ELSP-1550



APPLICATIONS:

Outdoor Residential Building,
Commercial Spaces, Industrial
Spaces, Hospitality & Retail



Features

- Higher Lumen Efficiency 110 lm/W
- Rated Life Time: 50,000 Hrs

Optional Features

- Dimming (DALI/1-10V)

PRODUCT PARAMETERS

PHYSICAL	
Housing	Die-Cast Aluminum
Diffuser	Toughened Glass
Finish	Graphite /White /Black
Mounting	Wall Recessed
OPTICAL	
Beam Angle	120°
UGR	--
ELECTRICAL	
CRI	≥80
CCT	3000K/4000K/6000K
Voltage / Frequency	220-240 VAC / 50-60Hz
Operating Temperature	-20°C to +50°C
Driver	In-Built

PRODUCT DETAILS

Product Code	Wattage	Lumen	Cut Out	Product Size
ELSP 1550-A	6W	720 lm	148x148x56 mm	L160xW160xH56 mm
ELSP 1550-B	8W	960 lm	202x202x56 mm	L220xW220xH60 mm
ELSP 1550-C	12W	1440 lm	232x216x56 mm	L245xW260xH60 mm

PRODUCT DRAWING

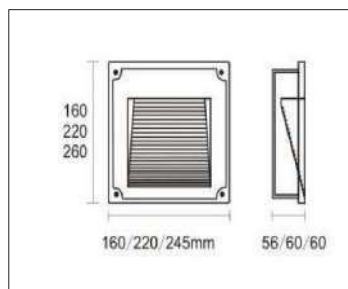

LIGHT DISTRIBUTION

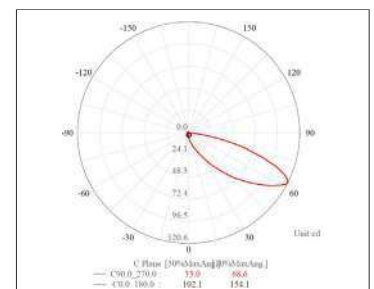

ELSP-1551



APPLICATIONS:

Outdoor Residential Building,
Commercial Spaces, Industrial
Spaces, Hospitality & Retail



Features

- Higher Lumen Efficiency 110 lm/W
- Rated Life Time: 50,000 Hrs

Optional Features

- Dimming (DALI/1-10V)

PRODUCT PARAMETERS

PHYSICAL	
Housing	Die-Cast Aluminum
Diffuser	Toughened Glass
Finish	Graphite /White /Black
Mounting	Wall Recessed
OPTICAL	
Beam Angle	120°
UGR	--
ELECTRICAL	
CRI	≥80
CCT	3000K/4000K/6000K
Voltage / Frequency	220-240 VAC / 50-60Hz
Operating Temperature	-20°C to +50°C
Driver	In-Built

PRODUCT DETAILS

Product Code	Wattage	Lumen	Cut Out	Product Size
ELSP-1551-A	6W	720 lm	145x88x71 mm	L162xW98xH85 mm
ELSP-1551-B	8W	960 lm	207x112x58 mm	L225xW125xH58 mm
ELSP-1551-C	15W	1440 lm	262x133x97 mm	L275xW145xH112 mm

PRODUCT DRAWING

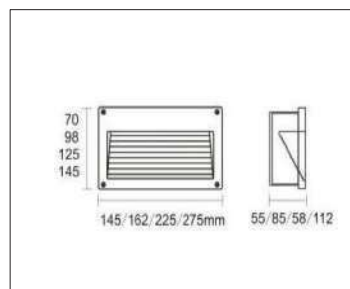

LIGHT DISTRIBUTION

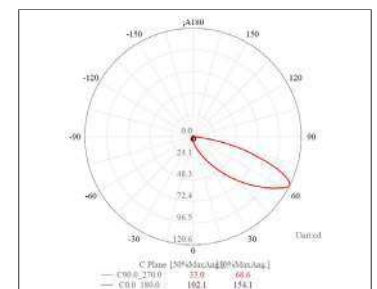

ELSP-1552

APPLICATIONS:

Outdoor Residential Building,
Commercial Spaces, Industrial
Spaces, Hospitality & Retail



Features

- Higher Lumen Efficiency 110 lm/W
- Rated Life Time: 50,000 Hrs

Optional Features

- Dimming (DALI/1-10V)

PRODUCT PARAMETERS

PHYSICAL	
Housing	Die-Cast Aluminum
Diffuser	Toughened Glass
Finish	Graphite /White /Black
Mounting	Wall Recessed
OPTICAL	
Beam Angle	40°
UGR	--
ELECTRICAL	
CRI	≥80
CCT	3000K/4000K/6000K
Voltage / Frequency	220-240 VAC / 50-60Hz
Operating Temperature	-20°C to +50°C
Driver	In-Built

PRODUCT DETAILS

Product Code	Wattage	Lumen	Cut Out	Product Size
ELSP 1552-A	1/3W	100/240 lm	74 mm	Ø82xH75 mm
ELSP 1552-B	1/3W	100/240 lm	74 mm	□84xH75 mm

PRODUCT DRAWING

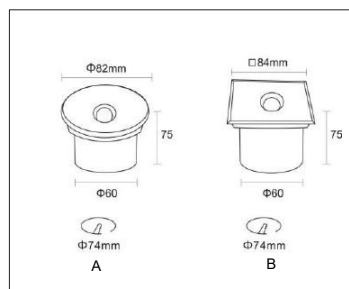

LIGHT DISTRIBUTION

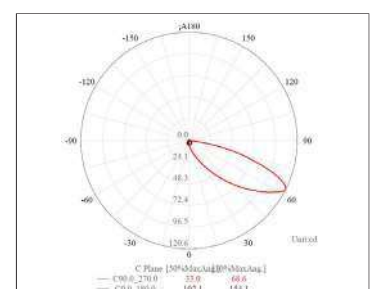

ELSP-1553

APPLICATIONS:

Outdoor Residential Building,
Commercial Spaces, Industrial
Spaces, Hospitality & Retail

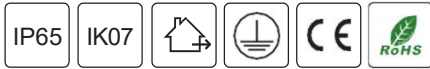

Features

- Rated Life Time: 50,000 Hrs

Optional Features

- Dimming(DALI/1-10V)

PRODUCT PARAMETERS

PHYSICAL	
Housing	Diecast Aluminum
Diffuser	Tempered Glass
Finish	Graphite /White /Black
Mounting	Wall Recessed
OPTICAL	
Beam Angle	40°
UGR	--
ELECTRICAL	
CRI	≥80
CCT	3000K/4000K/6000K
Voltage / Frequency	220-240 VAC / 50-60Hz
Operating Temperature	-20°C to +50°C
Driver	In Built

PRODUCT DETAILS

Product Code	Wattage	Product Size
ELSP 1553-A	5W	189xH89 mm

PRODUCT DRAWING

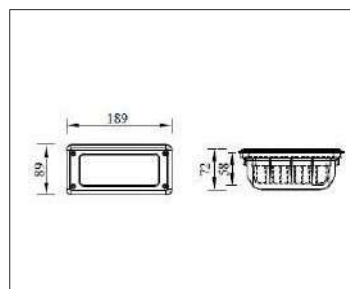

LIGHT DISTRIBUTION

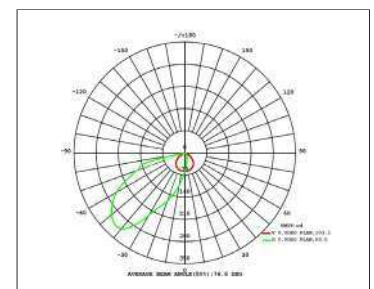



OUR KEY PROJECTS



KHALIFA UNIVERSITY

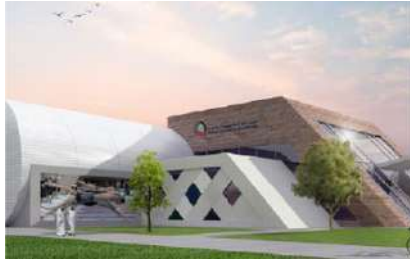

HIGHER COLLEGE OF TECHNOLOGY



AMITY SCHOOL



AMERICAN COMMUNITY SCHOOL



FUTURE SCHOOL



SHEIKH KHALIFA MEDICAL CITY



CORNICHE HOSPITAL



SHEIKH SHAKHBOUT MEDICAL CITY



ETIHAD TOWER



ETISALAT HQ-ABU DHABI



ABU DHABI MALL



EXOTIC CAR



URBAN CARS



EXPO 2020 LEBANON PAVILION



WAHAT AL KARAMA



Emirates Lighting Factory LLC.,
P.O.Box 45702, Plot No. 72, Sector M14, Mussafah Industrial Area,
Abu Dhabi, United Arab, Emirates
Tel: +971-2- 555 5690 Ext-200 | Email: elf@elfltg.ae



Asfar Lighting LLC.,
Murjan Building Airport Road, P.O.Box No: 716 Abu Dhabi,
United Arab, Emirates. Tel: +971-2-635 5002



Bin Moosa Group LLC.,
23rd & 25th Street, Hadbat Al Za Faranah, Zone 1,
Abu Dhabi, United Arab, Emirates. Tel: +971-2-626 3666

 [linkedin.com/company/emirates-lighting](https://www.linkedin.com/company/emirates-lighting)

 [facebook.com/elfltg](https://www.facebook.com/elfltg)

 [instagram.com/emirateslighting](https://www.instagram.com/emirateslighting)

www.emirateslighting.ae